

SURFACES

TEXTURES

ARCHITECTURE

**CONTEMPORARY  
MIXTURES  
SURFACES**  
&  
SIGNATURE  
SURFACES

Livingceramics

**Living**ceramics

**CONTEMPORARY MIXTURES SURFACES**

*WALL & FLOOR TILES  
PORCELAIN  
&  
WALL TILES  
DUCTILE*

**Allure**

Marbled Stone in Ceramics  
Piedra Veteada Cerámica

Pag. 51

**Bera&Beren**

Lusitan & Catalan Limestone Ceramics  
Caliza Lusitana & Catalana Cerámica

Pag. 53

**Blanc**

White Marble Stone in Ceramics  
Mármol Blanco en Cerámica

Pag. 55

**Cuit**

Mud Art in Ceramics  
Arte en Barro Cerámica

Pag. 57

**Eme**

Mediterranean Stone in Ceramics  
Piedra mediterránea Cerámica

Pag. 59

**Era**

Monocolor in Ceramics  
Monocolor en Cerámica

Pag. 61

**Floss**

Natural Cement Ceramics  
Cemento Natural Cerámico

Pag. 63

**Ground**

Mixed Surfaces Ceramics  
Mezcla de Superficies Cerámica

Pag. 65

**Gubi**

Microcement Ceramics  
Microcemento Cerámico

Pag. 67

**Kendo**

Jura Stone in Ceramics  
Piedra Jura en Cerámica

Pag. 69

**Kora**

Wildwood in Ceramics  
Madera Salvaje en Cerámica

Pag. 71

**Kovo**

Mixed Concrete in Ceramics  
Mezcla de Cementos en Cerámica

Pag. 73

**Lightwood**

Natural Brushed Oak Ceramics  
Roble Natural Cepillado Cerámico

Pag. 75

**Noon**

Northern Stone in Ceramics  
Piedra del Norte Cerámicas

Pag. 77

**Rem**

Sawn Wood in Ceramics  
Madera Aserrada en Cerámica

Pag. 79

**Uno**

Oak in Ceramics  
Roble en Cerámica

Pag. 81

**Verso Vein Cut**

Travertine Stone in Ceramics  
Piedra Travertino en Cerámica

Pag. 83

**Verso Cross Cut**

Travertine Stone in Ceramics  
Piedra Travertino en Cerámica

Pag. 85

**Vonn**

Textured Stone in Ceramics  
Piedra Texturada en Cerámica

Pag. 87

**Wam**

Limestone in Ceramics  
Piedra Caliza Cerámica

Pag. 89

**CONTEMPORARY MIXTURES SURFACES**

*WALL & FLOOR TILES  
THROUGH-BODY PORCELAIN*

**Kron Tech**

Concrete in Ceramics  
Cemento en Cerámica

Pag. 91

**Wega Tech**

Volcanic Stone in Ceramics  
Piedra Volcánica Cerámica

Pag. 93

**CONTEMPORARY MIXTURES SURFACES**

*WALL TILES  
WHITE BODY*

**Allure Wall**

Marbled Stone in Ceramics  
Piedra Veteada Cerámica

Pag. 95

**Bera&Beren Wall**

Lusitan & Catalan Limestone Ceramics  
Caliza Lusitana & Catalana Cerámica

Pag. 97

**Ground Wall**

Mixed Surfaces Ceramics  
Mezcla de Superficies Cerámica

Pag. 99

**Gubi Wall**

Microcement Ceramics  
Microcemento Cerámico

Pag. 101

**Mayolica**

Natural Mayolica Ceramics  
Mayolica Natural Cerámica

Pag. 103

**SIGNATURE SURFACES**

*WALL & FLOOR TILES  
PORCELAIN*

**Bisel**

by VictorCarrasco

Pag. 106

**Balance**

by VictorCarrasco

Pag. 112

**Cava**

by LucidiPevere

Pag. 116

**TECHNICAL INFORMATION  
INFORMACIÓN TÉCNICA**

**20MM.  
THICKNESS FLOOR**

Pag. 120

**Special Pieces  
Standard Step Tiles  
& Pool Special Pieces**

Pag. 124

**BATHROOM  
FURNITURE  
SERIES**

Pag. 127

**Recommendations  
Recomendaciones**

Pag. 128

**Sales Conditions  
Condiciones de Venta**

Pag. 130

# Life is For Living

At Living we are guided by the desire of creating versatile ceramic solutions for interior design and architecture. Claddings - on floors, walls, countertops, steps... - are the skin of our homes, and we believe that it is necessary to take care and pay attention to them. We feel a true passion for good design. We are committed to a material such as ceramics that makes it easier to obtain original and practical resources. Our ultimate objective is customer satisfaction, and we focus the professionalism and thoroughness of our work on this point. We strive in creating products that respond to today's requirements, that are adapted to the users needs, and are in line with the new trends. We are committed to avant-garde design. By combining creativity with the infinite possibilities of ceramics we have created Living, a brand that is capable of facing current challenges.

En Living nos guiamos por el deseo de crear soluciones cerámicas versátiles para el interiorismo y la arquitectura. Los recubrimientos de suelos, paredes, encimeras, peldaños... son la piel de nuestros hogares y espacios públicos; y creemos que es necesario cuidarlos y prestarles atención. Sentimos verdadera pasión por el buen diseño. Apostamos por un material que facilita la obtención de recursos originales y prácticos, como es la cerámica. Nuestro fin último es la satisfacción del cliente y en ello ponemos nuestra profesionalidad y la rigurosidad de nuestro trabajo. Nos esforzamos en crear productos que respondan a las exigencias actuales, adaptados a las necesidades de los usuarios y en consonancia con las nuevas tendencias. Comprometidos con el diseño de vanguardia y conjugando creatividad y las infinitas posibilidades que ofrece la cerámica, hemos creado Living, una marca capaz de afrontar los retos actuales.

Livingceramics



## SHOWROOM

We are non-conformists with a passion for detail and determined to achieve optimum results in everything we do. We believe that the best way of demonstrating our work is to share what we feel with you, which is why our head offices include a space that reflects the true character of our brand. These pages will take you on a tour of our Showroom; our home is ready to welcome you, so enjoy the visit and find out how ceramic tile architecture became our true passion and vocation. Welcome to Livingceramics.

Somos inconformistas, nos gustan los detalles e insistimos con el fin de obtener un resultado óptimo en todo lo que hacemos. Pensamos que la mejor manera de demostrar nuestro trabajo es que lo sientas como nosotros, por eso, en nuestras oficinas centrales, tenemos una muestra del carácter que respira la marca. En estas páginas, te invitamos a entrar en nuestro Showroom, nuestra casa se abre para recibirte, así que disfruta del paseo y descubre cómo la arquitectura cerámica se ha convertido en nuestra pasión. Bienvenido a Livingceramics.

## Sustainable Tiles Cerámica Sostenible

From Living we work under the criteria of respect for the environment, safety and health at work. This philosophy has led us to be part of the Green Building Council, a non-profit association formed by companies that work to make our environments sustainable and responsible. We ensure safety in the workplace by training our personnel in safety and environmental aspects. Concepts such as energy sustainability are important for the company, and this is demonstrated by the external audits that guarantee our quality seals. All our containers and packaging are recyclable. Even the catalog that you have in your hands, has been designed using FSC papers that support a controlled repopulation of one of our greatest legacies, the forests.

Desde Living trabajamos bajo los criterios de respeto al medio ambiente, la seguridad y la salud en el trabajo. Esta filosofía nos ha llevado a formar parte del Green Building Council, una asociación sin ánimo de lucro formada por empresas que trabajamos para que nuestros entornos sean sostenibles y responsables. Velamos por la seguridad en el ámbito laboral formando a nuestro personal en aspectos de seguridad y medio ambiente. Conceptos como la sostenibilidad energética son importantes para la empresa, y ello se demuestra con las auditorías externas que avalan nuestros sellos de calidad. Todos nuestros envases y embalajes son reciclables. Incluso el catálogo que tienes entre las manos, se ha diseñado utilizando papeles FSC que avalan una repoblación controlada de uno de nuestros mayores legados, los bosques.

GREEN BUILDING MEMBER / MIEMBRO DEL GREEN BUILDING COUNCIL  
CERTIFIED COMPANY ISO 9001 / EMPRESA CERTIFICADA ISO 9001  
USE OF CERTIFICATE FSC PAPER / USO DE PAPEL CON CERTIFICADO FSC



## The Smart Factory La Fábrica Inteligente



We understand that our parts must be unique and irreplaceable, which is why we have invested in the most advanced systems of production that exist in the market, never before present in the sector.

Looking to the future, we wanted to design a smart material, a product without limitations or restrictions for the most demanding architecture, capable of adapting to the most special projects. The special format of these pieces, up to 120x270cm, allows covering the space from floor to ceiling with a single piece, creating an infinity effect to the eye.

Entendemos que nuestras piezas deben ser únicas e irremplazables, es por ello por lo que hemos invertido en los sistemas de producción más vanguardistas que existen en el mercado, nunca antes presentes en el sector.

Con vistas al futuro, hemos querido diseñar un material inteligente, un producto sin limitaciones ni restricciones para la arquitectura más exigente, capaz de adaptarse a los proyectos más especiales. El formato de estas piezas, de 120x270cm, permite recubrir el espacio de suelo a techo con una sola pieza, creando un efecto de infinitud a la vista.

## High Performance Tiles Cerámica de Alto Rendimiento

The full body porcelain tile delivers certain advantages vs other collections, without losing all benefits the glaze porcelain offers, its main feature resides in its inside. The raw material that shapes the tile become uniform without any superficial decoration that delivers the same aesthetic throughout the tile, this particularity make it the best fit for all those spaces that demand the most hard wearing materials.

La cerámica técnica de alto rendimiento confiere ciertas ventajas con respecto a otras colecciones. Sin dejar de ofrecer todos los beneficios de un Gres Porcelánico, su característica más evidente se encuentra en su interior. La masa cerámica que conforma la pieza pasa a ser uniforme y deja de utilizarse una decoración superficial, para conferir a toda la pieza el mismo aspecto, incluyendo laterales e interior. Esta particularidad lo hace idóneo para revestir espacios con alto tráfico peatonal sometidos a un gran desgaste y que necesiten de un pavimento que ofrezca las más altas garantías superficiales.



## Corelith® Technology

Livingceramics introduces you to the innovative Corelith® technology, which allows us to design the core of the piece of our Tech Series, from the customised selection of each of its components, combined in different proportions, colours and gradings. The design of the core is a fundamental part of the surface appearance of the piece, allowing it to be seen as one whole piece and achieving flawless consistency between the surface, interior and edges. This fact dramatically increases the potential for producing worktops and decorative surfaces with visible edges.

Livingceramics presenta la novedosa tecnología Corelith®. Técnica que nos permite diseñar el núcleo de la pieza de nuestras colecciones de porcelánico técnico, a partir de la selección personalizada de cada uno de sus componentes, combinados en diferentes porcentajes, coloraciones y granulometrías. El diseño del núcleo es parte fundamental de la imagen superficial de la pieza, permitiendo que ésta se entienda como un todo, y consiguiendo una rigurosa similitud entre la superficie, su interior y sus bordes. Hecho que amplía notablemente la posibilidades de realización de encimeras y superficies decorativas con los cantos vistos.

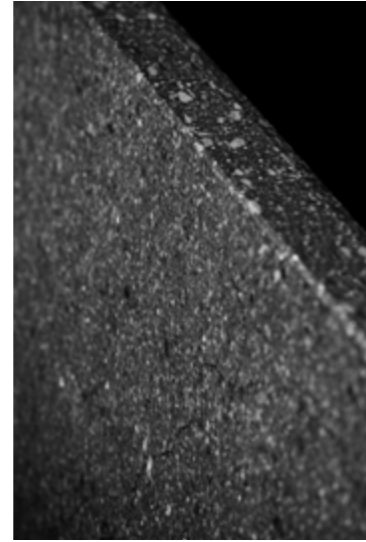

## 3D-Fit® Technology

Our collections with 3D-Fit® textures involve an innovative technique of graphical 3D digital printing. This process allows the image and the textures of the ceramics to work together perfectly, so that, along with the core designed using Corelith® technology, creates a surface with a much more realistic appearance and provides each piece with a unique and special character.

With materials like wood or stone, this effect could only be achieved if the texture and graphics were intrinsically linked. Now, as a result of our RDI, 3D-Fit® can be applied to a selection of our Series. The highest level of definition to make each surface appear much more realistic.

Nuestras colecciones con relieve 3D-Fit® incluyen una innovadora técnica de inyección gráfica mejorada. Este proceso consigue que la imagen y los relieves de la cerámica casen a la perfección, aportando una textura mucho más realista en la superficie y otorgando a cada pieza un carácter único y especial.

Este efecto sólo podía conseguirse en materiales naturales como la madera o la piedra en los que la textura y la gráfica están intrínsecamente unidos. Ahora, fruto del i+D+i, 3D-Fit® se aplica a una selección de nuestras colecciones. El más alto grado de definición que hace cada superficie, mucho más real.



## Honed

Surface finish with a soft and pleasant touch, made by lapping that respects the digital texture of the piece, which coincides with its graphic and gives a great realism to the surface of the material.

Acabado superficial de tacto suave y agradable, realizado mediante un lapado que respeta el relieve digital de la pieza, el cual coincide con la gráfica de la misma y que dota de un gran realismo a la superficie del material.



## Natural

The piece does not receive any treatment that modifies the surface. Each tile is made up of multiple ceramic flakes which compact during the firing process. The result is a slightly textured surface.

En este acabado la pieza no recibe ningún tratamiento que modifique la superficie. Cada baldosa se compone de múltiples escamas cerámicas, las cuales se compactan durante el proceso de cocción, dando lugar a una superficie ligeramente texturizada.

## Anti-Slip

Our new anti-slip finish presents a new smoother appearance, while maintaining all the properties that guarantee total user safety to be used on outdoor surfaces and wet areas, such as the edges of swimming pools or snow and rain climates.

Nuestro nuevo acabado antideslizante presenta un nuevo aspecto más suave, al tiempo que mantiene todas las propiedades que garantizan la total seguridad del usuario para poder ser utilizado en superficies de exterior y zonas húmedas, como los bordes de piscinas o climas de nieve y lluvia.

## Bush Hammered Anti-Slip

Extra smooth and matte surface finish, which adds depth to the graphic and highlights the nuances of the designs of the pieces.

Acabado superficial extra suave y mate, el cual aporta profundidad a la gráfica y resalta los matices de los diseños de las piezas.

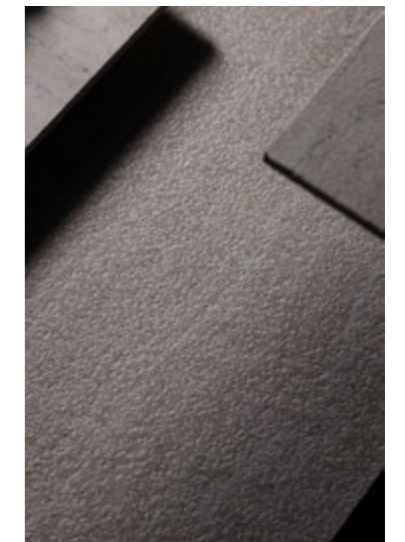



# Ductile



## Lighter Más Ligero

Thanks to their slimline 6mm thickness and new formula.  
Gracias a su espesor de 6 mm. y a una nueva formulación cerámica.



## Swifter Más Rápido

Their new formula offsets surface stress, making any cutting work much swifter and cleaner.  
Su composición evita tensiones superficiales obteniendo cortes rápidos y limpios.



## Easier Más Fácil

The tiles ductile properties make them easy to lay, avoiding the need for expensive tile adhesives.  
La ductilidad de la pieza permite una instalación cómoda, evitando utilizar adhesivos de alto coste.



## Eco-Friendlier Más Ecológico

Due to the big reduction in emissions from the manufacturing and transport processes.  
Reducimos un gran número de emisiones en su fabricación y transporte.

The Ductile collection by Livingceramics stands out for its versatility and simple tile-laying process. A new ceramic material with special characteristics, Ductile can be used to dress up indoor walls in much swifter, more effortless style. Thanks to the tiles' new chemical formula, they can easily be precision cut or drilled. Standard drill bits and cutting discs and less complex tile adhesives can be used with Ductile, cutting tile-laying costs and saving on time.

La versatilidad y facilidad de instalación se representan en la colección Ductile de Livingceramics. Un nuevo material cerámico con unas características muy especiales que hace que revestir interiores se transforme en una tarea mucho más rápida y fácil.

La nueva composición química del material hace que la realización de cortes y perforaciones sea un proceso preciso y simple. Ductile permite utilizar brocas y discos estándar, adhesivos menos complejos en su composición y por ende, abaratar los procesos de instalación y optimizar tiempos.

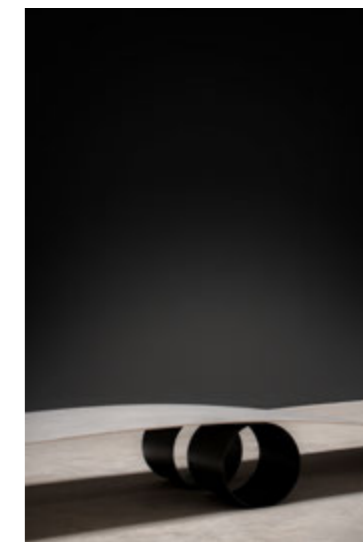

SME INNOVATIVE / PYME INNOVADORA

The Spanish Ministry for Science, Innovation & Universities rewards Livingceramics efforts in the fields of R&D and innovation.

El Ministerio de Ciencia, Innovación y Universidades reconoce a Livingceramics la inversión en investigación y Desarrollo de productos diferenciadores en la industria cerámica actual.





# Living ceramics

## CONTEMPORARY MIXTURES SURFACES

Wall&Floor Tiles · Porcelain

### Allure

Marbled Stone in Ceramics  
Piedra Veteada Cerámica



### Bera&Beren

Lusitan & Catalan Limestone Ceramics  
Caliza Lusitana & Catalana Cerámica



### Blanc

White Marble Stone in Ceramics  
Mármol Blanco en Cerámica

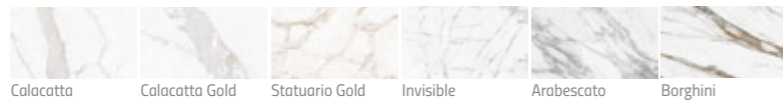

### Cuit

Mud Art in Ceramics  
Arte en Barro Cerámico



### Eme

Mediterranean Stone in Ceramics  
Piedra mediterránea Cerámica

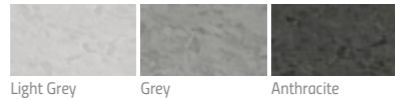

### Era

Monocolor in Ceramics  
Monocolor en Cerámica



### Floss

Natural Cement Ceramics  
Cemento Natural Cerámico

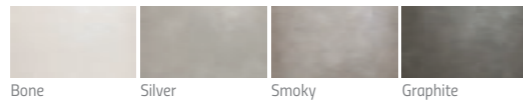

### Ground

Mixed Surfaces Ceramics  
Mezcla de Superficies Cerámica

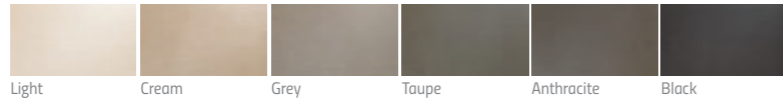

### Gubi

Microcement Ceramics  
Microcemento Cerámico

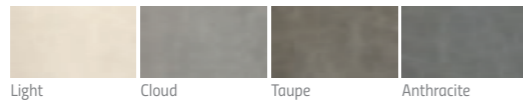

### Kendo

Jura Stone in Ceramics  
Piedra Jura en Cerámica

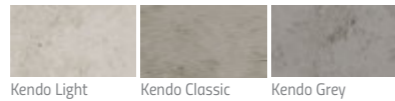

### Kora

Wildwood in Ceramics  
Madera Salvaje en Cerámica

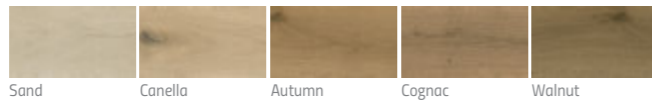

### Kovo

Mixed Concrete in Ceramics  
Mezcla de Cementos en Cerámica

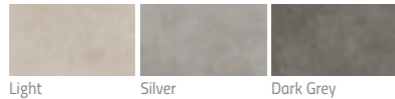

### Lightwood

Natural Brushed Oak Ceramics  
Roble Natural Cepillado Cerámico



### Noon

Northern Stone in Ceramics  
Piedra del Norte Cerámica

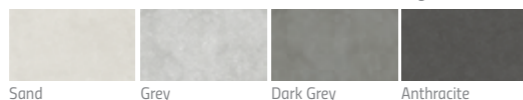

### Rem

Sawn Wood in Ceramics  
Madera Aserrada en Cerámica

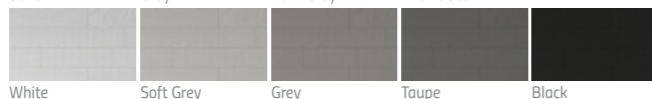

### Uno

Oak Ceramics  
Roble Cerámico

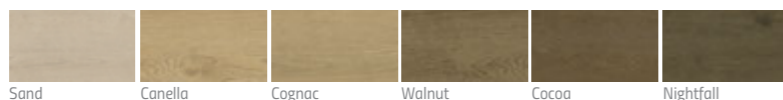

### Verso Vein Cut

Travertine Stone in Ceramics  
Piedra Travertino en Cerámica

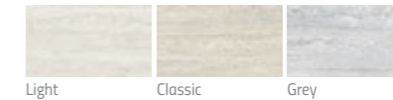

### Verso Cross Cut

Travertine Stone in Ceramics  
Piedra Travertino en Cerámica

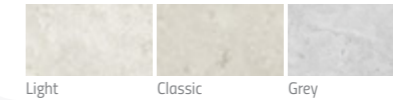

### Vonn

Textured Stone in Ceramics  
Piedra Texturada en Cerámica

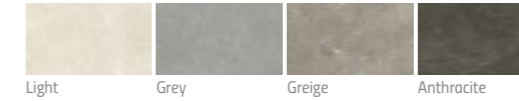

### Wam

Limestone in Ceramics  
Piedra Caliza Cerámica



### Kron Tech

Concrete in Tech. Porcelain  
Cemento en Porcelánico Téc.



### Wega Tech

Volcanic Stone in Tech. Porcelain  
Piedra Volcánica en Porcelánico Téc.

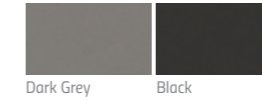

## CONTEMPORARY MIXTURES SURFACES

Wall Tiles · White Body

### Allure Wall

Marbled Stone in Ceramics  
Piedra Veteada Cerámica



### Ground Wall

Mixed Surfaces Ceramics  
Mezcla de Superficies Cerámica

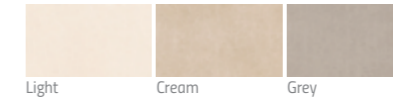

### Bera&Beren Wall

Lusitan & Catalan Limestone Ceramics  
Caliza Lusitana & Catalana Cerámica

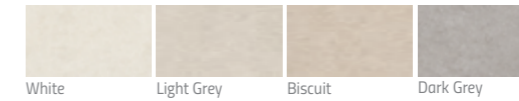

### Gubi Wall

Microcement Ceramics  
Microcemento Cerámico

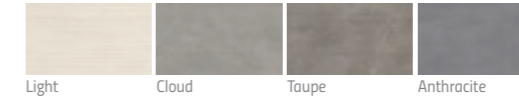

### Mayolica

Natural Mayolica Ceramics  
Mayolica Natural Cerámica



## SIGNATURE SURFACES

Wall&Floor Tiles

### Bisel

by VictorCarrasco



### Balance

by VictorCarrasco



### Cava

by LucidiPevere

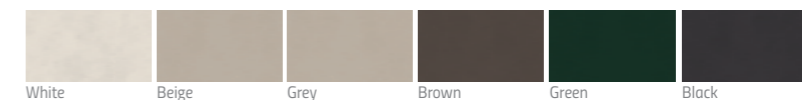

**THE ART OF MIXING  
EL ARTE DE COMBINAR**

All our Contemporary Mixtures Surfaces collections we are launching from Living suggest a rich blend of materials and finishes. They are designed as a whole, so that they are easy to combine with each other, regardless of the line and the chromatic choice. All the collections are found in a wide range of formats, responding to the contemporary architecture's demands and allowing almost infinite combinations. We have used current technologies such as ceramic color digital printing, and technology forefront methods such as directly printing on the glazing and "masking", which have enabled us to create light and beautiful designs with great personality and with unprecedented finishes and textures.

Todas y cada una de las colecciones Contemporary Mixtures Surfaces que lanzamos desde Living, proponen una rica mezcla de materiales y acabados. Están concebidas como un todo, de forma que resulta sencillo combinar unas con otras, independientemente de la colección y la elección cromática. Todas las colecciones se encuentran en una amplia variedad de formatos, respondiendo a las exigencias de arquitectura del momento y permitiendo combinaciones casi infinitas. Hemos utilizado tecnologías actuales como impresión digital en colores cerámicos, y métodos a la vanguardia de la técnica, como la impresión directa en esmaltes y el masking, que nos han permitido crear diseños ligeros y bellos, de gran personalidad y con acabados y texturas inéditas.



**Allure Anthracite**  
120x270 cm. (48"x106")



**Beren Black**  
90x270 cm. (36"x106")

**Bathroom Furniture Series**  
**W.37.90 Bera&Beren Black Basin**  
20x90x52 cm.  
8"x36"x21"



**Beren Dark Grey**  
90x270 cm. (36"x106")



**Blanc Calacatta**  
120x270 cm. (48"x106")



**Blanc Statuario Gold**  
120x120 cm. (48"x48")

**Ductile**  
Blanc Arabescato  
90x270 cm. (36"x106")

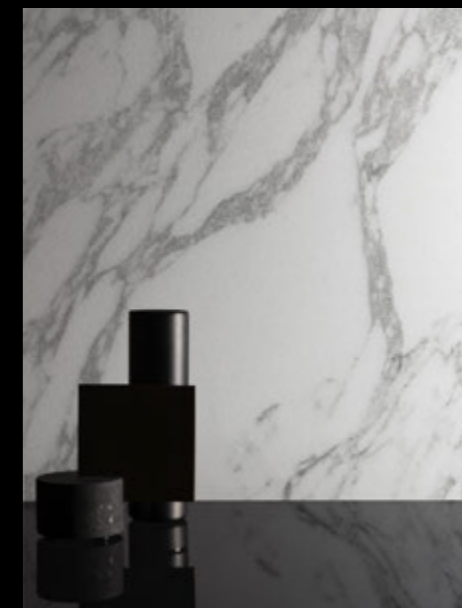



Cuit Clay  
120x270 cm. (48"x106")



Cuit Clay  
120x270 cm. (48"x106")



**Eme Grey**  
120x270 cm. (48"x106")



**Ground Taupe**  
90x90 cm. (36"x36")



**Floss Bone**  
90x90 cm. (36"x36")



**Gubi Anthracite**  
90x90 cm. (36"x36")



Kendo Light Honed  
120x270 cm. (48"x106")



Kendo Light Honed  
120x270 cm. (48"x106")





**Kora Canella**  
22,5x160 cm. (9"x63")



**Kora Sand**  
22,5x160 cm. (9"x63")

**Kora Autumn**  
22,5x200 cm. (9"x79")



**Uno Cocoa**  
22,5x200 cm. (9"x79")



**Lightwood Canella**  
20x180 cm. (8"x72")



**Ductile**  
Kovo Dark Grey  
60x120 cm. (24"x48")



**Ductile**  
Noon Sand  
90x270 cm. (36"x106")

**Bathroom Furniture Series**  
L.28 [240] Noon Sand Basin  
Shadow Dry Oak Frame



Rem Black  
5x40 cm. (2"x16")



Rem Black  
5x40 cm. (2"x16")

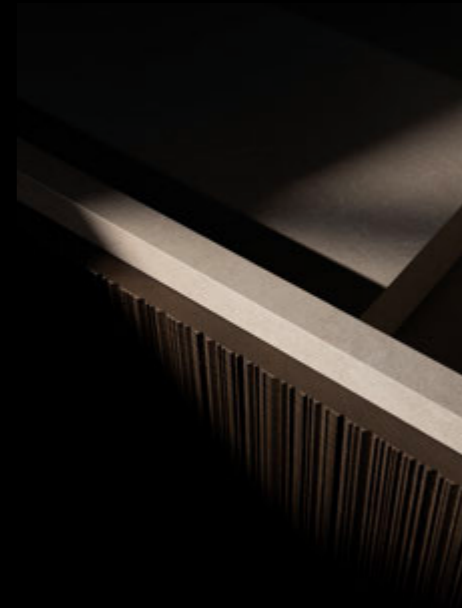

Vonn Light  
120x120 cm. (48"x48")

**Bathroom Furniture Series**  
L.28 [240 cm.] Vonn Light  
Cross Dry Oak Frame



Verso Vein Cut Light  
120x270 cm. (48"x106")

**Bathroom Furniture Series**  
A.71 [240 cm.] Verso Vein Cut Light  
Cross Dry Oak Line. 240



Verso Vein Cut Light  
120x270 cm. (48"x106")



Verso Cross Cut Light  
120x270 cm. (48"x106")



Verso Cross Cut Light  
120x270 cm. (48"x106")



Ground Wall Cream Twist  
30x90 cm. (12"x36")

Allure Wall Anthracite Wave  
30x90 (12"x36")

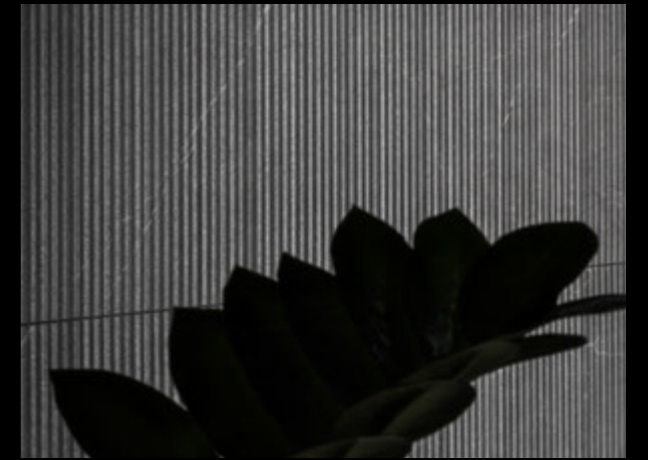

Beren Wall Dark Grey Six  
30x90 cm. (12"x36")



Gubi Wall Anthracite Peak  
30x90 cm. (12"x36")



SIGNATURE  
SURFACES



Cava by LucidiPevere  
Cava Green  
7,5x30 7.B + Joint Terra di Siena

LucidiPevere

SIGNATURE  
SURFACES

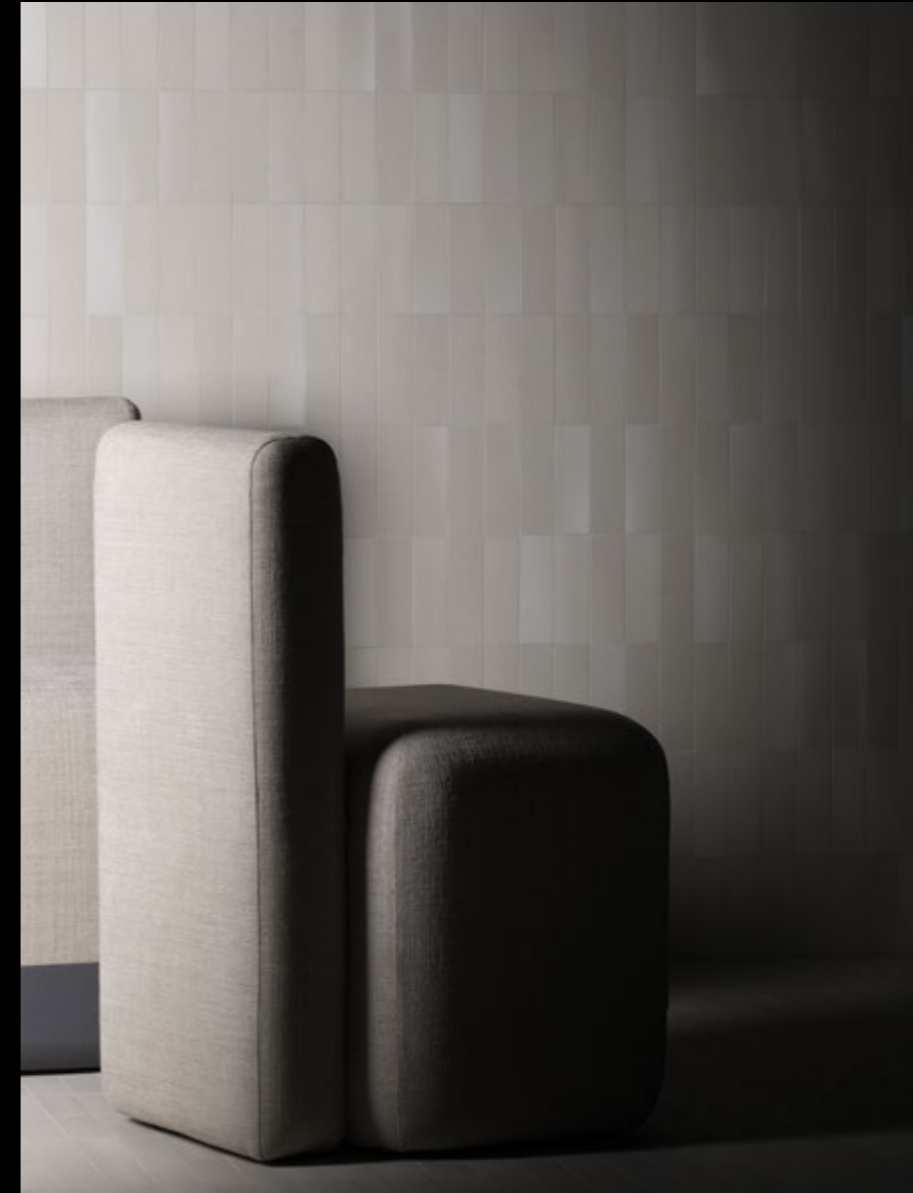

Balance by Víctor Carrasco  
Balance Clay  
5x15 cm. (2"x6")

Víctor Carrasco

SIGNATURE  
SURFACES

**CONTEMPORARY  
MIXTURES  
SURFACES**  
&  
SIGNATURE  
SURFACES



Bisel by Víctor Carrasco  
Bisel Tuscan Red  
15x15 cm. (6"x6")

Víctor Carrasco



Natural Finish      Anti-slip Finish

Color Body Porcelain & Ductile / Porcelánico Masa Coloreada y Ductile  
Rectified / Destonified V.2 / Rectificado / Destonificado V.2  
N° Designs By Format / N° De Diseños Por Formato :  
120x270: 7 / D-90x270: 7 / D-60x120: 14 / 120x120: 14 / 60x120: 14 / 90x90: 16 / 45x90: 32 / 60x60: 28 / 30x60: 56

**3D-Fit®**  
Technology

Natural Finish  
Escala 1/4

Available Sizes / Formatos Disponibles

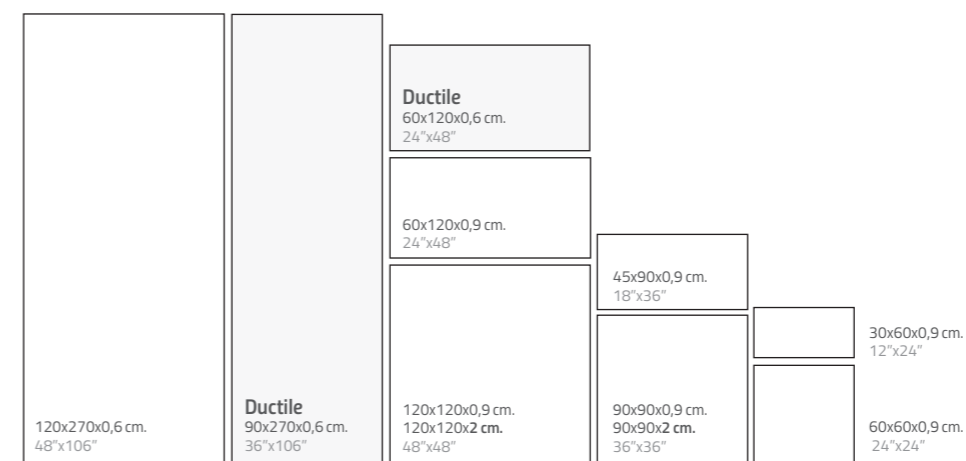

Complements / Complementos

Step Tile & Countertops Availables. Pag. 124.  
Peldaños y Encimeras disponibles. Pag. 124.

-  **Deco Mosaic**  
Net 24"x24"  
Malla 60x60 cm.  
Real 59,8x59,8 cm.
-  **Mosaic 25**  
Net 12"x12"  
Malla 30x30 cm.  
Real 29,8x29,8 cm.
-  **Mosaic 55**  
Net 12"x12"  
Malla 30x30 cm.  
Real 29,8x29,8 cm.
-  **Mureto Mosaic**  
Net 12"x18"  
Malla 30x45 cm.  
Real 29,8x29,8 cm.
-  **Mureto 3D Mosaic**  
Net 6"x36"  
Malla 15x90 cm.  
Real 15x60 cm.

Ductile Wall Tiles Available Sizes & Finishes / Formatos y Acabados Disponibles en Revestimientos Ductile

Nominal Size Formato Nominal	Real Size Formato Real	Natural Natural	Price Code Código Precio	Pz/Box	M2/Box	Kg/Box	Box/Pa	M2/Pa	Kg/Pa
Ductile 60x120 cm. 24"x48"	59,8x119,8x0,6 cm.	●	620	3	2,15	25,80	24	51,48	649
Ductile 90x270 cm. 36"x106"	89,8x269,8x0,6 cm.	●	970	1	2,42	29,04	24	58,08	801

Porcelain Tiles Available Sizes & Finishes / Formatos y Acabados Disponibles en Porcelánico

Nominal Size Formato Nominal	Real Size Formato Real	Natural Natural C1 · R9 · CA	Anti-Slip Antideslizante C3 · R11 · CC	Price Code Código Precio	Pz/Box	M2/Box	Kg/Box	Box/Pa	M2/Pa	Kg/Pa
30x60 cm. 12"x24"	29,8x59,8x0,9 cm.	●	●	30	6	1,07	22,00	48	51,36	1094
60x60 cm. 24"x24"	59,8x59,8x0,9 cm.	●	●	60	3	1,07	23,22	40	42,91	962
45x90 cm. 18"x36"	44,8x89,8x0,9 cm.	●	●	45	3	1,21	25,50	32	38,62	849
90x90 cm. 36"x36"	89,8x89,8x0,9 cm.	●	●	90	2	1,61	34,00	24	38,71	846
*90x90x2 cm. 36"x36"	89,8x89,8x2 cm.		●	94	1	0,81	37,09	24	19,35	946
60x120 cm. 24"x48"	59,8x119,8x0,9 cm.	●	●	62	2	1,43	30,32	24	34,32	767
120x120 cm. 48"x48"	119,8x119,8x0,9 cm.	●	●	120	1	1,44	30,50	40	57,41	1265
*120x120x2 cm. 48"x48"	119,8x119,8x2 cm.		●	121	1	1,44	66,02	16	22,96	1140
120x270 cm. 48"x106"	119,8x269,8x0,6 cm.	●		276	1	3,23	45,50	24	77,52	1250
Deco Mosaic	59,8x59,8x0,9 cm.	●	●	560	4	0,92	20,00	24	22,10	510
Mosaic 25	29,8x29,8x0,9 cm.	●	●	25	5	0,44	9,00	60	26,40	576
Mosaic 55	29,8x29,8x0,9 cm.	●	●	55	5	0,44	9,00	60	26,40	576
Mureto Mosaic	29,8x29,8x0,9 cm.	●	●	300	5	0,44	9,00	40	17,60	395
Mureto 3D Mosaic	15x60x0,9 cm.	●	●	595	4	0,35	7,50	20	7,03	175

Available Colours / Colores Disponibles

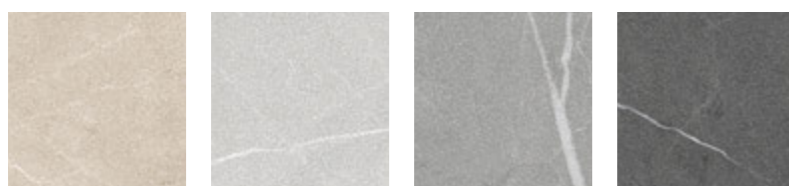

\*Allure Sand      \*Allure Light Grey      Allure Grey      \*Allure Anthracite

\*20mm. Thickness Available Colour  
\*Color Disponible en 20mm.



Natural Finish    Bush Hammered    Anti-slip Finish

Color Body Porcelain & Ductile / Porcelánico Masa Coloreada y Ductile  
Rectified / Destonified V.2 / Rectificado / Destonificado V.2  
N° Designs By Format / N° De Diseños Por Formato :  
120x270: 7 / D-90x270: 7 / D-60x120: 14 / 120x120: 14 / 60x120: 14 / 90x90: 16 / 45x90: 32  
60x60: 28 / 30x60: 56 / 10x60: 168 / 5x60: 336

Natural Finish  
Graphic Scale 1/4

## Available Colours / Colores Disponibles



\*Bera White    \*Beren Light Grey    \*Beren Biscuit    \*Beren Greige    \*Beren Dark Grey    Beren Coal    Beren Black

\*20mm. Thickness Available Colour  
\*Color Disponible en 20mm.

## Available Sizes / Formatos Disponibles

Step Tile & Countertops Available. Pag. 124.  
Peldaños y Encimeras disponibles. Pag. 124.

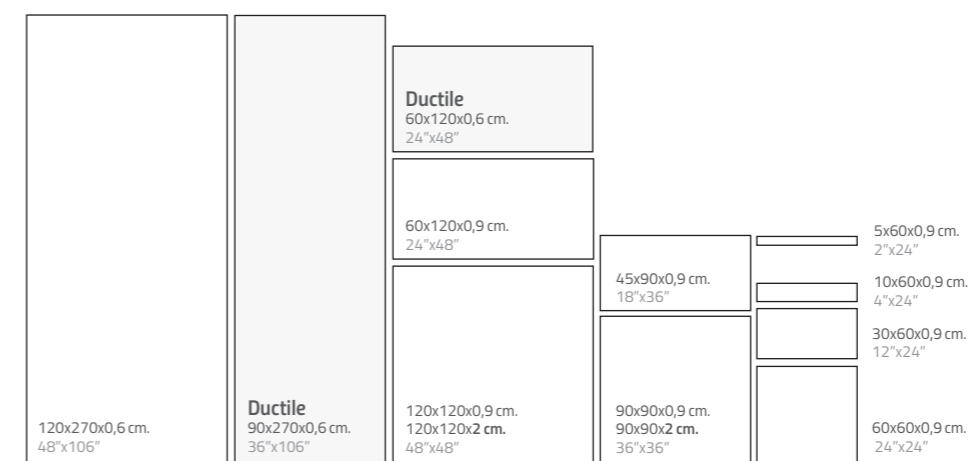

## Complements / Complementos



## Ductile Wall Tiles Available Sizes & Finishes / Formatos y Acabados Disponibles en Revestimientos Ductile

Nominal Size Formato Nominal	Real Size Formato Real	Natural Natural	Price Code Código Precio	Pz/Box	M2/Box	Kg/Box	Box/Pa	M2/Pa	Kg/Pa
Ductile 60x120 cm. 24"x48"	59,8x119,8x0,6 cm.	●	620	3	2,15	25,80	24	51,48	649
Ductile 90x270 cm. 36"x106"	89,8x269,8x0,6 cm.	●	970	1	2,42	29,04	24	58,08	801

## Porcelain Tiles Available Sizes & Finishes / Formatos y Acabados Disponibles en Porcelánico

Nominal Size Formato Nominal	Real Size Formato Real	Natural Natural C1 · R9 · CA	B. Hammered Abujardado C2 · R10 · CB	Anti-Slip Antideslizante C3 · R11 · CC	Price Code Código Precio	Pz/Box	M2/Box	Kg/Box	Box/Pa	M2/Pa	Kg/Pa
5x60 cm. 2"x24"	4,8x59,8x0,9 cm.	●	●	●	5	20	0,57	13,20	60	34,44	832
10x60 cm. 4"x24"	9,8x59,8x0,9 cm.	●	●	●	10	10	0,59	13,30	60	35,40	838
30x60 cm. 12"x24"	29,8x59,8x0,9 cm.	●	●	●	30	6	1,07	22,00	48	51,36	1094
60x60 cm. 24"x24"	59,8x59,8x0,9 cm.	●	●	●	60	3	1,07	23,22	40	42,91	962
45x90 cm. 18"x36"	44,8x89,8x0,9 cm.	●	●	●	45	3	1,21	25,50	32	38,62	849
90x90 cm. 36"x36"	89,8x89,8x0,9 cm.	●	●	●	90	2	1,61	34,00	24	38,71	846
*90x90x2 cm. 36"x36"	89,8x89,8x2 cm.	●	●	●	94	1	0,81	37,09	24	19,35	946
60x120 cm. 24"x48"	59,8x119,8x0,9 cm.	●	●	●	62	2	1,43	30,32	24	34,32	767
120x120 cm. 48"x48"	119,8x119,8x0,9 cm.	●	●	●	120	1	1,44	30,50	40	57,41	1265
*120x120x2 cm. 48"x48"	119,8x119,8x2 cm.	●	●	●	121	1	1,44	66,02	16	22,96	1140
120x270 cm. 48"x106"	119,8x269,8x0,6 cm.	●	●	●	276	1	3,23	45,50	24	77,52	1250
Mosaic 25	29,8x29,8x0,9 cm.	●	●	●	25	5	0,44	9,00	60	26,40	576
Mosaic 55	29,8x29,8x0,9 cm.	●	●	●	55	5	0,44	9,00	60	26,40	576
Mosaic 315	29,8x29,4x0,9 cm.	●	●	●	315	5	0,44	9,00	60	26,40	576
Mureto Mosaic	29,8x29,8x0,9 cm.	●	●	●	300	5	0,44	9,00	40	17,60	395

# Blanc

White Marble Stone in Ceramics  
Mármol Blanco en Cerámica



Natural Finish

Color Body Porcelain & Ductile / Porcelánico Masa Coloreada y Ductile  
Rectified / Destonified V.2 / Rectificado / Destonificado V.2  
N° Designs By Format / N° De Diseños Por Formato :  
120x270: 7 / D-90x270: 7 / D-60x120: 14-24 / 120x120: 14 / 60x120: 14-24 / 90x90: 16 / 45x90: 32

**3D-Fit®**  
Technology

Natural Finish  
Escala 1/4

## Available Sizes / Formatos Disponibles

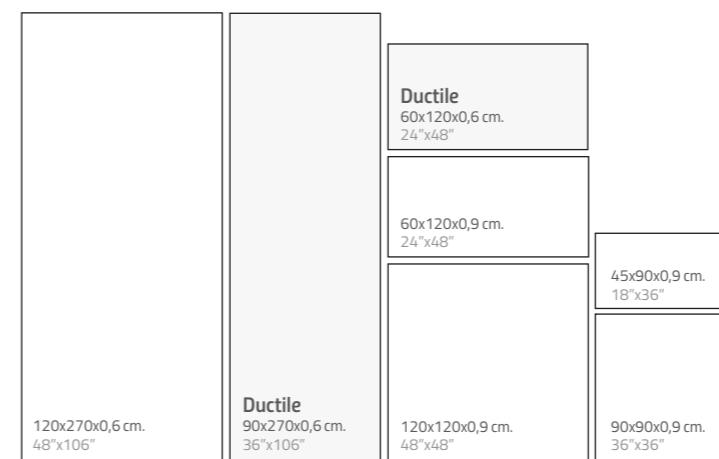

## Complements / Complementos

Step Tile & Countertops Availables. Pag. 124.  
Peldaños y Encimeras disponibles. Pag. 124.



Mosaic 25  
Net 12"x12"  
Malla 30x30 cm.  
Real 29,8x29,8 cm.



Mosaic 55  
Net 12"x12"  
Malla 30x30 cm.  
Real 29,8x29,8 cm.



Mureto Mosaic  
Net 12"x18"  
Malla 30x45 cm.  
Real 29,8x29,8 cm.

## Ductile Wall Tiles Available Sizes & Finishes / Formatos y Acabados Disponibles en Revestimientos Ductile

Nominal Size Formato Nominal	Real Size Formato Real	Natural Natural	Price Code Código Precio	Pz/Box	M2/Box	Kg/Box	Box/Pa	M2/Pa	Kg/Pa
Ductile 60x120 cm. 24"x48"	59,8x119,8x0,6 cm.	●	620	3	2,15	25,80	24	51,48	649
Ductile 90x270 cm. 36"x106"	89,8x269,8x0,6 cm.	●	970	1	2,42	29,04	24	58,08	801

## Porcelain Tiles Available Sizes & Finishes / Formatos y Acabados Disponibles en Porcelánico

Nominal Size Formato Nominal	Real Size Formato Real	Natural Natural C1 · R9 · CA	Price Code Código Precio	Pz/Box	M2/Box	Kg/Box	Box/Pa	M2/Pa	Kg/Pa
45x90 cm. 18"x36"	44,8x89,8x0,9 cm.	●	45	3	1,21	25,50	30	36,21	832
90x90 cm. 36"x36"	89,8x89,8x0,9 cm.	●	90	2	1,61	34,00	24	38,71	846
60x120 cm. 24"x48"	59,8x119,8x0,9 cm.	●	62	2	1,43	30,32	24	34,32	728
120x120 cm. 48"x48"	119,8x119,8x0,9 cm.	●	120	1	1,44	30,50	40	57,41	1265
120x270 cm. 48"x106"	119,8x269,8x0,6 cm.	●	276	1	3,23	45,50	24	77,52	1250
Mosaic 25	29,8x29,8x0,9 cm.	●	25	5	0,44	9,02	60	26,40	565
Mosaic 55	29,8x29,8x0,9 cm.	●	55	5	0,44	9,02	60	26,40	565
Mureto Mosaic	29,8x29,8x0,9 cm.	●	300	5	0,44	8,94	40	17,60	382

## Available Colours / Colores Disponibles

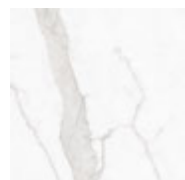

Blanc Calacatta

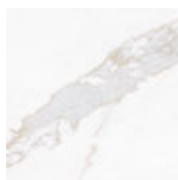

Blanc Calacatta Gold

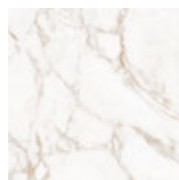

Blanc Statuario Gold



Blanc Invisible

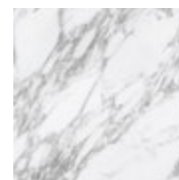

Blanc Arabescato

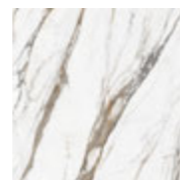

Blanc Borghini

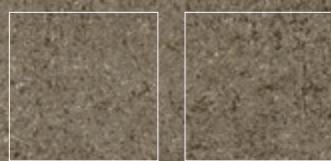

Natural Finish    Anti-slip Finish

**3D-Fit**<sup>®</sup>  
Technology

Color Body Porcelain & Ductile / Porcelánico Masa Coloreada y Ductile  
Rectified / Destonified V.2 / Rectificado / Destonificado V.2  
N° Designs By Format / N° De Diseños Por Formato :  
120x270: 7 / D-90x270: 7 / D-60x120: 24 / 120x120: 14 / 60x120: 24 / 90x90: 16 / 45x90: 32 / 60x60: 48 / 30x60: 96

Natural Finish  
Escala 1/3

Available Sizes / Formatos Disponibles

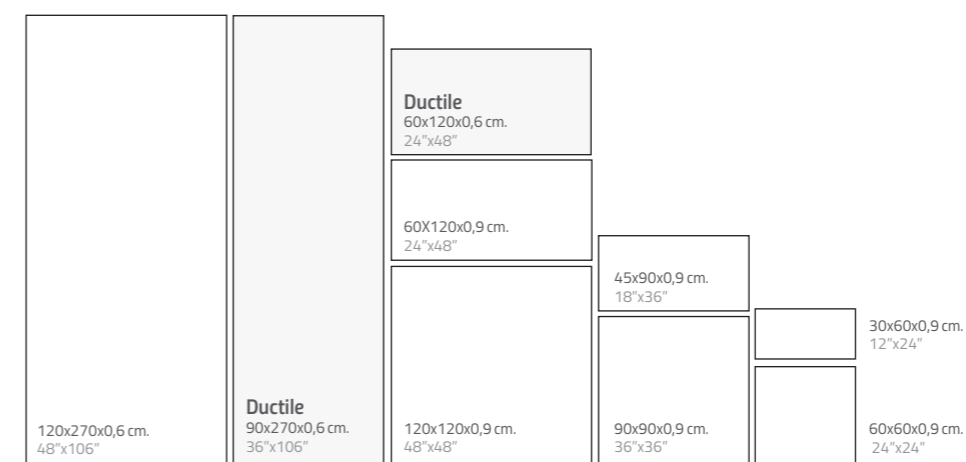

Complements / Complementos

Step Tile & Countertops Availables. Pag. 124.  
Peldaños y Encimeras disponibles. Pag. 124.

 **Mosaic 25**  
Net 12"x12"  
Malla 30x30 cm.  
Real 29,8x29,8 cm.

 **Mosaic 55**  
Net 12"x12"  
Malla 30x30 cm.  
Real 29,8x29,8 cm.

 **Spike Mosaic**  
Net 12"x18"  
Malla 30x45 cm.  
Real 22,6x43 cm.

Ductile Wall Tiles Available Sizes & Finishes / Formatos y Acabados Disponibles en Revestimientos Ductile

Nominal Size Formato Nominal	Real Size Formato Real	Natural Natural	Price Code Código Precio	Pz/Box	M2/Box	Kg/Box	Box/Pa	M2/Pa	Kg/Pa
Ductile 60x120 cm. 24"x48"	59,8x119,8x0,6 cm.	●	620	3	2,15	25,80	24	51,48	649
Ductile 90x270 cm. 36"x106"	89,8x269,8x0,6 cm.	●	970	1	2,42	29,04	24	58,08	801

Porcelain Tiles Available Sizes & Finishes / Formatos y Acabados Disponibles en Porcelánico

Nominal Size Formato Nominal	Real Size Formato Real	Natural Natural C2 · R10 · CB	Anti-Slip Antideslizante C3 · R11 · CC	Price C. C. Precio	Pz/Box	M2/Box	Kg/Box	Box/Pa	M2/Pa	Kg/Pa
30x60 cm. 12"x24"	29,8x59,8x0,9 cm.	●	●	30	6	1,07	22,00	48	51,36	1094
60x60 cm. 24"x24"	59,8x59,8x0,9 cm.	●	●	60	3	1,07	23,22	40	42,91	962
45x90 cm. 18"x36"	44,8x89,8x0,9 cm.	●	●	45	3	1,21	25,50	32	38,62	849
90x90 cm. 36"x36"	89,8x89,8x0,9 cm.	●	●	90	2	1,61	34,00	24	38,71	846
60x120 cm. 24"x48"	59,8x119,8x0,9 cm.	●	●	62	2	1,43	30,32	24	34,32	767
120x120 cm. 48"x48"	119,8x119,8x0,9 cm.	●	●	120	1	1,44	30,50	40	57,41	1265
120x270 cm. 48"x106"	119,8x269,8x0,6 cm.	●	●	276	1	3,23	45,50	24	77,52	1250
Mosaic 25	29,8x29,8x0,9 cm.	●	●	25	5	0,44	9,00	60	26,40	576
Mosaic 55	29,8x29,8x0,9 cm.	●	●	55	5	0,44	9,00	60	26,40	576
Spike Mosaic	22,6x43	●	●	303	3	0,89	19,00	24	21,27	480

Available Colours / Colores Disponibles

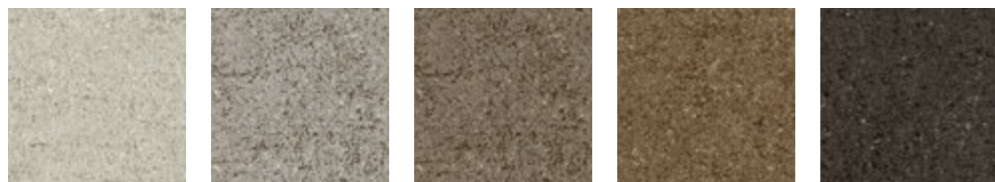

Cuit Bone    Cuit Grey    Cuit Clay    Cuit Terra    Cuit Charcoal

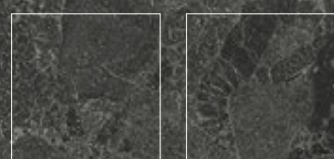
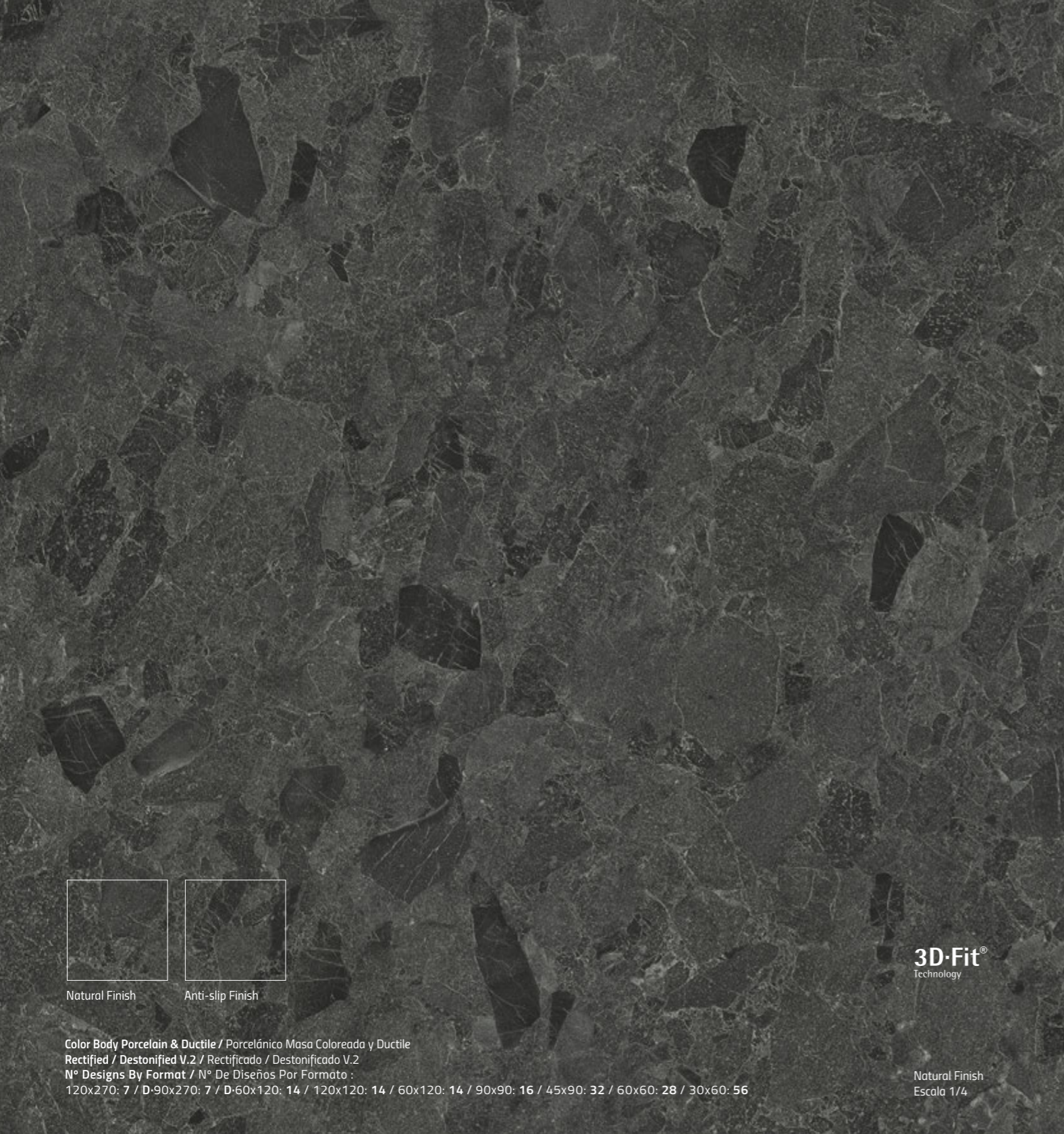

Natural Finish      Anti-slip Finish

Color Body Porcelain & Ductile / Porcelánico Masa Coloreada y Ductile  
Rectified / Destonified V.2 / Rectificado / Destonificado V.2  
N° Designs By Format / N° De Diseños Por Formato :  
120x270: 7 / D-90x270: 7 / D-60x120: 14 / 120x120: 14 / 60x120: 14 / 90x90: 16 / 45x90: 32 / 60x60: 28 / 30x60: 56

**3D-Fit**  
Technology

Natural Finish  
Escala 1/4

Available Sizes / Formatos Disponibles

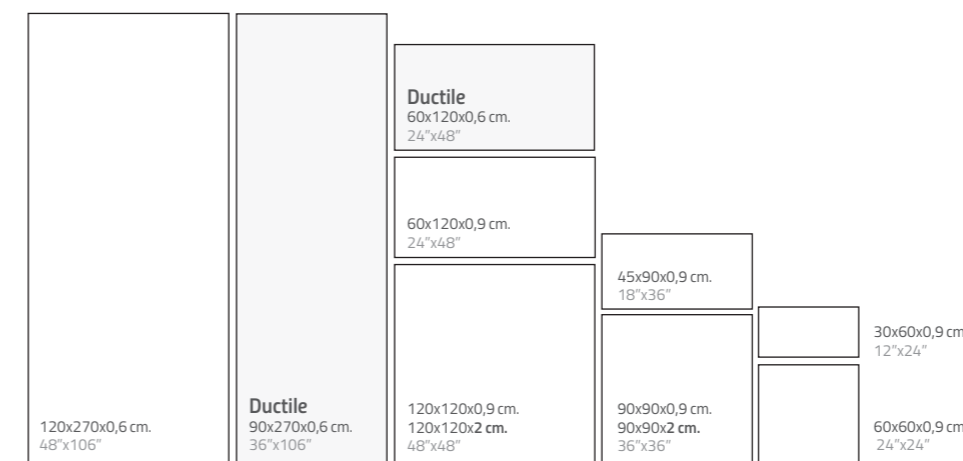

Complements / Complementos

Step Tile & Countertops Availables. Pag. 124.  
Peldaños y Encimeras disponibles. Pag. 124.



Mosaic 25  
Net 12"x12"  
Malla 30x30 cm.  
Real 29,8x29,8 cm.



Mosaic 55  
Net 12"x12"  
Malla 30x30 cm.  
Real 29,8x29,8 cm.



Mureto Mosaic  
Net 12"x18"  
Malla 30x45 cm.  
Real 29,8x29,8 cm.

Ductile Wall Tiles Available Sizes & Finishes / Formatos y Acabados Disponibles en Revestimientos Ductile

Nominal Size Formato Nominal	Real Size Formato Real	Natural Natural	Price Code Código Precio	Pz/Box	M2/Box	Kg/Box	Box/Pa	M2/Pa	Kg/Pa
Ductile 60x120 cm. 24"x48"	59,8x119,8x0,6 cm.	●	620	3	2,15	25,80	24	51,48	649
Ductile 90x270 cm. 36"x106"	89,8x269,8x0,6 cm.	●	970	1	2,42	29,04	24	58,08	801

Porcelain Tiles Available Sizes & Finishes / Formatos y Acabados Disponibles en Porcelánico

Nominal Size Formato Nominal	Real Size Formato Real	Natural Natural C1 · R9 · CA	Anti-Slip Antideslizante C3 · R11 · CC	Price Code Código Precio	Pz/Box	M2/Box	Kg/Box	Box/Pa	M2/Pa	Kg/Pa
30x60 cm. 12"x24"	29,8x59,8x0,9 cm.	●	●	30	6	1,07	22,00	48	51,36	1094
60x60 cm. 24"x24"	59,8x59,8x0,9 cm.	●	●	60	3	1,07	23,22	40	42,91	962
45x90 cm. 18"x36"	44,8x89,8x0,9 cm.	●	●	45	3	1,21	25,50	32	38,62	849
90x90 cm. 36"x36"	89,8x89,8x0,9 cm.	●	●	90	2	1,61	34,00	24	38,71	846
*90x90x2 cm. 36"x36"	89,8x89,8x2 cm.	●	●	94	1	0,81	37,09	24	19,35	946
60x120 cm. 24"x48"	59,8x119,8x0,9 cm.	●	●	62	2	1,43	30,32	24	34,32	767
120x120 cm. 48"x48"	119,8x119,8x0,9 cm.	●	●	120	1	1,44	30,50	40	57,41	1265
*120x120x2 cm. 48"x48"	119,8x119,8x2 cm.	●	●	121	1	1,44	66,02	16	22,96	1140
120x270 cm. 48"x106"	119,8x269,8x0,6 cm.	●	●	276	1	3,23	45,50	24	77,52	1250
Mosaic 25	29,8x29,8x0,9 cm.	●	●	25	5	0,44	9,00	60	26,40	576
Mosaic 55	29,8x29,8x0,9 cm.	●	●	55	5	0,44	9,00	60	26,40	576
Mureto Mosaic	29,8x29,8x0,9 cm.	●	●	300	5	0,44	9,00	40	17,60	395

Available Colours:

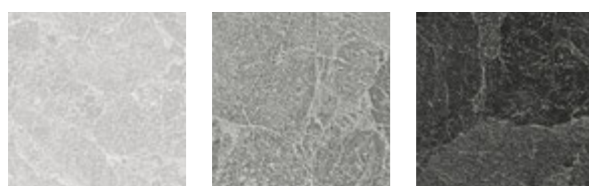

Eme Light Grey      \*Eme Grey      Eme Anthracite

\*20mm. Thickness Available Colour  
\*Color Disponible en 20mm.



Natural Finish

**Ductile**  
Rectified / Destonified V.1 / Rectificado / Destonificado V.1  
N° Designs By Format / N° De Diseños Por Formato :  
D-90x270: 1 / D-60x120: 1

Natural Finish  
Escala 1/4

Available Colours / Colores Disponibles



Era Pure White   Era Pure Matt White   Era Ivory   Era Soft Grey   Era Grey   Era Taupe   Era Black



Era Sandalwood   Era Sky Blue   Era Navy   Era Green   Era Burgundy   Era Charcoal

Available Sizes / Formatos Disponibles

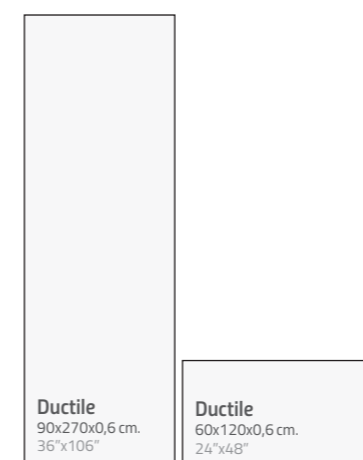

**Ductile**  
90x270x0,6 cm.  
36"x106"

**Ductile**  
60x120x0,6 cm.  
24"x48"

Ductile Wall Tiles Available Sizes & Finishes / Formatos y Acabados Disponibles en Revestimientos Ductile

Nominal Size Formato Nominal	Real Size Formato Real	Natural Natural	Price Code Código Precio	Pz/Box	M2/Box	Kg/Box	Box/Pa	M2/Pa	Kg/Pa
Ductile 60x120 cm. 24"x48"	59,8x119,8x0,6 cm.	●	620	3	2,15	25,80	24	51,48	649
Ductile 90x270 cm. 36"x106"	89,8x269,8x0,6 cm.	●	970	1	2,42	29,04	24	58,08	801





Natural Finish      Anti-slip Finish

Color Body Porcelain / Porcelánico Masa Coloreada  
Rectified / Destonified V.3 / Rectificado / Destonificado V.3  
N° Designs By Format / N° De Diseños Por Formato :  
120x270: 7 / 120x120: 14 / 60x120: 14 / 90x90: 16 / 45x90: 32 / 60x60: 28 / 30x60: 56 / 10x60: 168

Natural Finish  
Escala 1/4

Available Colours / Colores Disponibles



Floss Bone      Floss Silver      Floss Smoky      Floss Graphite

Available Sizes / Formatos Disponibles

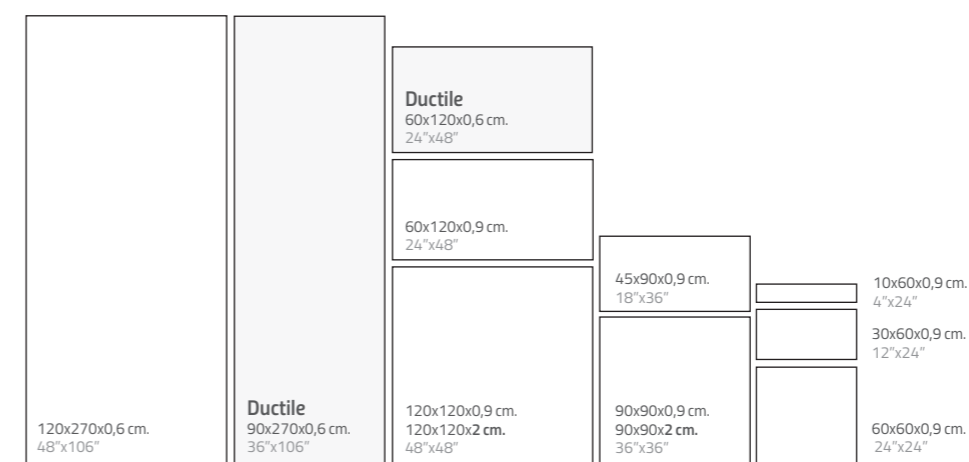

Complements / Complementos

Step Tile & Countertops Available. Pag. 124.  
Peldaños y Encimeras disponibles. Pag. 124.



Ductile Wall Tiles Available Sizes & Finishes / Formatos y Acabados Disponibles en Revestimientos Ductile

Nominal Size Formato Nominal	Real Size Formato Real	Natural Natural	Price Code Código Precio	Pz/Box	M2/Box	Kg/Box	Box/Pa	M2/Pa	Kg/Pa
Ductile 60x120 cm. 24"x48"	59,8x119,8x0,6 cm.	●	620	3	2,15	25,80	24	51,48	649
Ductile 90x270 cm. 36"x106"	89,8x269,8x0,6 cm.	●	970	1	2,42	29,04	24	58,08	801

Porcelain Tiles Available Sizes & Finishes / Formatos y Acabados Disponibles en Porcelánico

Nominal Size Formato Nominal	Real Size Formato Real	Natural Natural C1 · R9 · CA	Anti-Slip Antideslizante C3 · R11 · CC	Price Code Código Precio	Pz/Box	M2/Box	Kg/Box	Box/Pa	M2/Pa	Kg/Pa
10x60 cm. 4"x24"	9,8x59,8x0,9 cm.	●	●	10	10	0,59	13,30	60	35,40	838
30x60 cm. 12"x24"	29,8x59,8x0,9 cm.	●	●	30	6	1,07	22,00	48	51,36	1094
60x60 cm. 24"x24"	59,8x59,8x0,9 cm.	●	●	60	3	1,07	23,22	40	42,91	962
45x90 cm. 18"x36"	44,8x89,8x0,9 cm.	●	●	45	3	1,21	25,50	32	38,62	849
90x90 cm. 36"x36"	89,8x89,8x0,9 cm.	●	●	90	2	1,61	34,00	24	38,71	846
60x120 cm. 24"x48"	59,8x119,8x0,9 cm.	●	●	62	2	1,43	30,32	24	34,32	767
120x120 cm. 48"x48"	119,8x119,8x0,9 cm.	●	●	120	1	1,44	30,50	40	57,41	1265
120x270 cm. 48"x106"	119,8x269,8x0,6 cm.	●	●	276	1	3,23	45,50	24	77,52	1250
Mosaic 25	29,8x29,8x0,9 cm.	●	●	25	5	0,44	9,00	60	26,40	576
Mosaic 55	29,8x29,8x0,9 cm.	●	●	55	5	0,44	9,00	60	26,40	576
Mosaic 315	29,8x29,4x0,9 cm.	●	●	315	5	0,44	9,00	60	26,40	576
Mureto Mosaic	29,8x29,8x0,9 cm.	●	●	300	5	0,44	9,00	40	17,60	395



Natural Finish

Color Body Porcelain / Porcelánico Masa Coloreada  
Rectified / Destonified V.1 / Rectificado / Destonificado V.1  
N° Designs By Format / N° De Diseños Por Formato :  
90X90 (And special Shapes): 16 / 45x90: 32 / 60x60: 28 / 30x60: 56 / 10x60: 168

Natural Finish  
Escala 1/4

Available Sizes / Formatos Disponibles

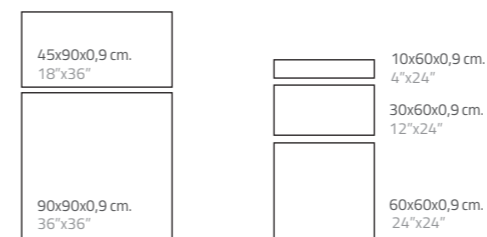

Special Shapes in 90x90 cm:

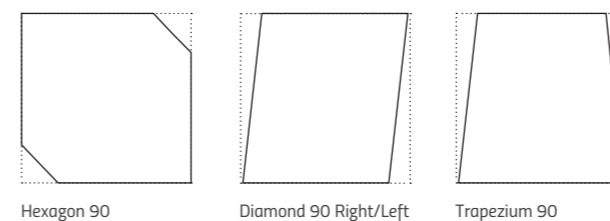

Complements / Complementos

Step Tile & Countertops Available. Pag. 124.  
Peldaños y Encimeras disponibles. Pag. 124.

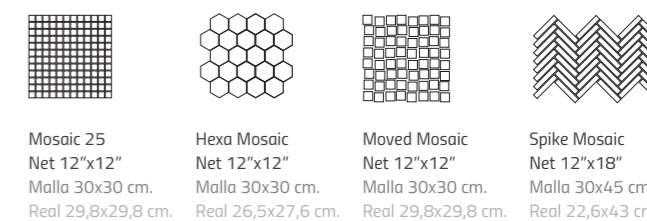

Available Colours / Colores Disponibles



Ground Light

Ground Cream

Ground Grey

Ground Taupe

Ground Anthracite

Ground Black

Porcelain Tiles Available Sizes & Finishes / Formatos y Acabados Disponibles en Porcelánico

Nominal Size Formato Nominal	Real Size Formato Real	Natural Natural C2 · R10 · CB	Price Code Código Precio	Pz/Box	M2/Box	Kg/Box	Box/Pa	M2/Pa	Kg/Pa
10x60 cm. 4"x24"	9,8x59,8x0,9 cm.	●	10	10	0,59	13,30	60	35,40	838
30x60 cm. 12"x24"	29,8x59,8x0,9 cm.	●	30	8	1,43	27,00	40	57,60	1100
60x60 cm. 24"x24"	59,8x59,8x0,9 cm.	●	60	4	1,43	27,00	32	46,08	960
45x90 cm. 18"x36"	44,8x89,8x0,9 cm.	●	45	3	1,21	25,50	32	38,62	849
90x90 cm. 36"x36"	89,8x89,8x0,9 cm.	●	90	2	1,62	40,00	27	43,74	1100
90x90 Hexagon	89,8x86	●	91	1	0,77	20,00	44	34,10	846
90x90 Diamond	89,8x79	●	92	1	0,71	18,50	44	31,24	786
90x90 Trapezium	89,8x79	●	93	1	0,71	18,50	44	31,24	786
Mosaic 25	29,8x29,8x0,9 cm.	●	25	5	0,44	9,00	60	26,40	576
Hexa Mosaic	26,5x27,6	●	301	5	0,33	6,50	60	19,80	426
Moved Mosaic	29,8x29,8	●	302	5	0,44	9,00	60	26,40	576
Spike Mosaic	22,6x43	●	303	5	0,47	10,75	40	18,80	465



Natural Finish      Anti-slip Finish

Color Body Porcelain & Ductile / Porcelánico Masa Coloreada y Ductile  
Rectified / Destonified V.2 / Rectificado / Destonificado V.2  
N° Designs By Format / N° De Diseños Por Formato :  
120x270: 7 / D-90x270: 7 / D-60x120: 14 / 120x120: 14 / 60x120: 14 / 90x90: 16 / 45x90: 32 / 60x60: 28 / 30x60: 56 / 10x60: 168

**3D-Fit**<sup>®</sup>  
Technology

Natural Finish  
Escala 1/4

Available Colours / Colores Disponibles



\*Gubi Light      \*Gubi Cloud      Gubi Taupe      Gubi Anthracite

\*20mm. Thickness Available Colour  
\*Color Disponible en 20mm.

Available Sizes / Formatos Disponibles

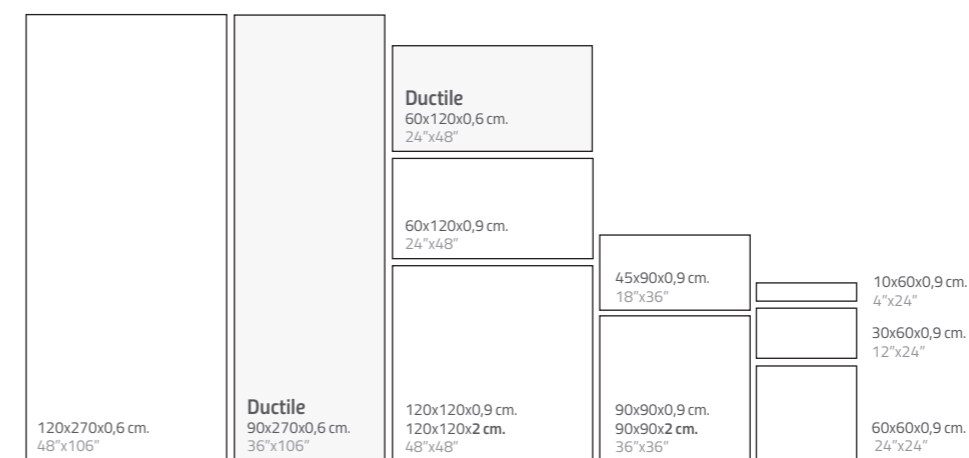

Complements / Complementos

Step Tile & Countertops Availables. Pag. 124.  
Peldaños y Encimeras disponibles. Pag. 124.

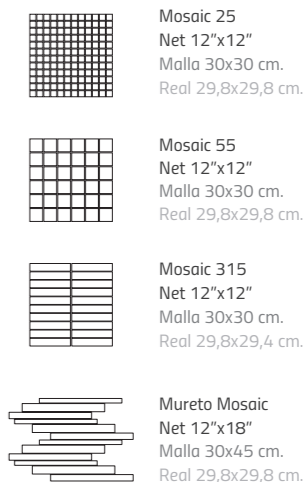

Ductile Wall Tiles Available Sizes & Finishes / Formatos y Acabados Disponibles en Revestimientos Ductile

Nominal Size Formato Nominal	Real Size Formato Real	Natural Natural	Price Code Código Precio	Pz/Box	M2/Box	Kg/Box	Box/Pa	M2/Pa	Kg/Pa
Ductile 60x120 cm. 24"x48"	59,8x119,8x0,6 cm.	●	620	3	2,15	25,80	24	51,48	649
Ductile 90x270 cm. 36"x106"	89,8x269,8x0,6 cm.	●	970	1	2,42	29,04	24	58,08	801

Porcelain Tiles Available Sizes & Finishes / Formatos y Acabados Disponibles en Porcelánico

Nominal Size Formato Nominal	Real Size Formato Real	Natural Natural C1 · R9 · CA	Anti-Slip Antideslizante C3 · R11 · CC	Price Code Código Precio	Pz/Box	M2/Box	Kg/Box	Box/Pa	M2/Pa	Kg/Pa
10x60 cm. 4"x24"	9,8x59,8x0,9 cm.	●	●	10	10	0,59	13,30	60	35,40	838
30x60 cm. 12"x24"	29,8x59,8x0,9 cm.	●	●	30	6	1,07	22,00	48	51,36	1094
60x60 cm. 24"x24"	59,8x59,8x0,9 cm.	●	●	60	3	1,07	23,22	40	42,91	962
45x90 cm. 18"x36"	44,8x89,8x0,9 cm.	●	●	45	3	1,21	25,50	32	38,62	849
90x90 cm. 36"x36"	89,8x89,8x0,9 cm.	●	●	90	2	1,61	34,00	24	38,71	846
*90x90x2 cm. 36"x36"	89,8x89,8x2 cm.	●	●	94	1	0,81	37,09	24	19,35	946
60x120 cm. 24"x48"	59,8x119,8x0,9 cm.	●	●	62	2	1,43	30,32	24	34,32	767
120x120 cm. 48"x48"	119,8x119,8x0,9 cm.	●	●	120	1	1,44	30,50	40	57,41	1265
*120x120x2 cm. 48"x48"	119,8x119,8x2 cm.	●	●	121	1	1,44	66,02	16	22,96	1140
120x270 cm. 48"x106"	119,8x269,8x0,6 cm.	●	●	276	1	3,23	45,50	24	77,52	1250
Mosaic 25	29,8x29,8x0,9 cm.	●	●	25	5	0,44	9,00	60	26,40	576
Mosaic 55	29,8x29,8x0,9 cm.	●	●	55	5	0,44	9,00	60	26,40	576
Mosaic 315	29,8x29,4x0,9 cm.	●	●	315	5	0,44	9,00	60	26,40	576
Mureto Mosaic	29,8x29,8x0,9 cm.	●	●	300	5	0,44	9,00	40	17,60	395



Honed Finish    Natural Finish    B.H. Finish    B.H. Anti-Slip Finish

Color Body Porcelain & Ductile / Porcelánico Masa Coloreada y Ductile  
Rectified / Destonified V.3 / Rectificado / Destonificado V.3  
N° Designs By Format / N° De Diseños Por Formato :  
120x270: 7 / D-90x270: 7 / D-60x120: 24 / 120x120: 14 / 60x120: 24 / 90x90: 16 / 45x90: 32 / 60x60: 48 / 30x60: 96

**3D-Fit®**  
Technology

Natural Finish  
Escala 1/4

Available Colours / Colores Disponibles

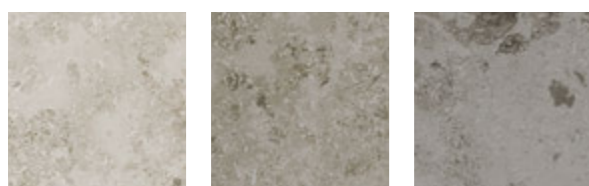

\*Kendo Light    \*Kendo Classic    Kendo Grey

\*20mm. Thickness Available Colour  
\*Color Disponible en 20mm.

Available Sizes / Formatos Disponibles

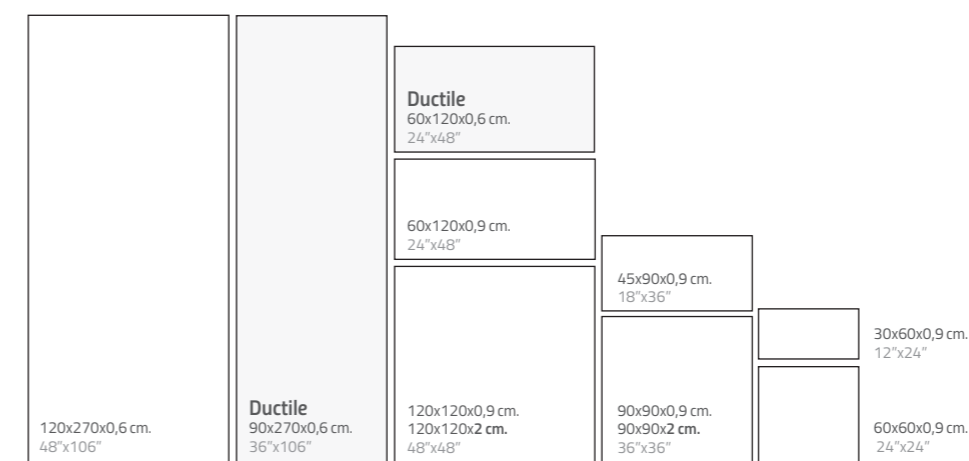

Complements / Complementos

Step Tile & Countertops Availables. Pag. 124.  
Peldaños y Encimeras disponibles. Pag. 124.



Mosaic 25  
Net 12"x12"  
Malla 30x30 cm.  
Real 29,8x29,8 cm.



Mosaic 55  
Net 12"x12"  
Malla 30x30 cm.  
Real 29,8x29,8 cm.



Mureto Mosaic  
Net 12"x18"  
Malla 30x45 cm.  
Real 29,8x29,8 cm.

Ductile Wall Tiles Available Sizes & Finishes / Formatos y Acabados Disponibles en Revestimientos Ductile

Nominal Size Formato Nominal	Real Size Formato Real	Natural Natural	Price Code Código Precio	Pz/Box	M2/Box	Kg/Box	Box/Pa	M2/Pa	Kg/Pa
Ductile 60x120 cm. 24"x48"	59,8x119,8x0,6 cm.	●	620	3	2,15	25,80	24	51,48	649
Ductile 90x270 cm. 36"x106"	89,8x269,8x0,6 cm.	●	970	1	2,42	29,04	24	58,08	801

Porcelain Tiles Available Sizes & Finishes / Formatos y Acabados Disponibles en Porcelánico

Nominal Size Formato Nominal	Real Size Formato Real	Honed Apomazado	Natural Natural C2 · R10 · CB	B.Hammered Abujardado C2 · R10 · CB	B. H. Anti-Slip Abujardado AS C3 · R11 · CC	Price Code Código Precio	Pz/Box	M2/ Box	Kg/Box	Box/Pa	M2/Pa	Kg/Pa
30x60 cm. 12"x24"	29,8x59,8x0,9 cm.	●	●		●	30 / 30H	6	1,07	22,00	48	51,36	1094
60x60 cm. 24"x24"	59,8x59,8x0,9 cm.	●	●		●	60 / 60H	3	1,07	23,22	40	42,91	962
45x90 cm. 18"x36"	44,8x89,8x0,9 cm.	●	●		●	45 / 45H	3	1,21	25,50	32	38,62	849
90x90 cm. 36"x36"	89,8x89,8x0,9 cm.	●	●		●	90 / 90H	2	1,61	34,00	24	38,71	846
*90x90x2 cm. 36"x36"	89,8x89,8x2 cm.				●	94	1	0,81	37,09	24	19,35	946
60x120 cm. 24"x48"	59,8x119,8x0,9 cm.	●	●		●	62 / 62H	2	1,43	30,32	24	34,32	767
120x120 cm. 48"x48"	119,8x119,8x0,9 cm.	●	●		●	120 / 120H	1	1,44	30,50	40	57,41	1265
*120x120x2 cm. 48"x48"	119,8x119,8x2 cm.				●	121	1	1,44	66,02	16	22,96	1140
120x270 cm. 48"x106"	119,8x269,8x0,6 cm.	●	●	●		276 / 276H	1	3,23	45,50	24	77,52	1250
Mosaic 25	29,8x29,8x0,9 cm.	●	●		●	25 / 25H	5	0,44	9,00	60	26,40	576
Mosaic 55	29,8x29,8x0,9 cm.	●	●		●	55 / 55H	5	0,44	9,00	60	26,40	576
Mureto Mosaic	29,8x29,8x0,9 cm.	●	●		●	300 / 300H	5	0,44	9,00	40	17,60	395

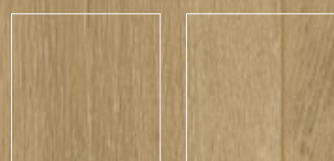

Natural Finish    Anti-slip Finish

Color Body Porcelain / Porcelánico Masa Coloreada  
Rectified / Destonified V.3 / Rectificado / Destonificado V.3  
N° Designs By Format / N° De Diseños Por Formato :  
22,5x200: 21 / 22,5x160: 39 / 20x120: 39

**3D-Fit®**  
Technology

Natural Finish  
Escala 1/4

Available Sizes / Formatos Disponibles



20x120x0,9 cm.  
8"x48"



22,5x160x0,9 cm.  
9"x63"

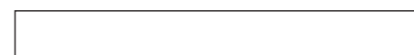

22,5x200x0,9 cm.  
9"x79"

Complements / Complementos

Step Tile & Countertops Availables. Pag. 124.  
Peldaños y Encimeras disponibles. Pag. 124.



Mosaic 330  
Net 12"x12"  
Malla 30x30 cm.  
Real 29,8x29,8 cm.

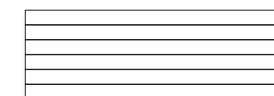

Mosaic 590  
Net 12"x36"  
Malla 30x90 cm.  
Real 29,8x89,8 cm.

Available Colours / Colores Disponibles

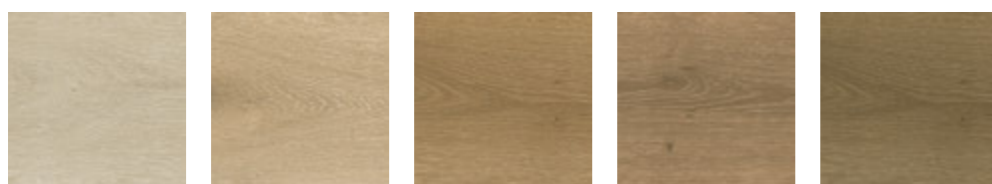

Kora Sand    Kora Canela    Kora Autumn    Kora Cognac    Kora Walnut

Porcelain Tiles Available Sizes & Finishes / Formatos y Acabados Disponibles en Porcelánico

Nominal Size Formato Nominal	Real Size Formato Real	Natural Natural C2·R10·CB	Anti-Slip Antideslizante C3·R11	Price Code Código Precio	Pz/Box	M2/Box	Kg/Box	Box/Pa	M2/Pa	Kg/Pa
20x120 cm. 8"x48"	19,8x119,8x0,9 cm.	●	●	20	5	1,19	25,15	45	53,55	1165
22,5x160 cm. 9"x63"	22,3x159,8x0,9 cm.	●	●	23	3	1,06	22,13	54	57,72	1230
22,5x200 cm. 9"x79"	22,3x199,8x0,9 cm.	●	●	22	2	0,89	18,46	63	56,19	1163
Mosaic 330	29,8x29,8x0,9 cm.	●	●	330	5	0,44	10,50	60	26,40	666
Mosaic 590	29,8x89,8x0,9 cm.	●	●	590	3	0,81	18,30	20	16,20	398



Natural Finish      Anti-slip Finish

Color Body Porcelain & Ductile / Porcelánico Masa Coloreada y Ductile  
Rectified / Destonified V.2 / Rectificado / Destonificado V.2  
N° Designs By Format / N° De Diseños Por Formato :  
120x270: 7 / D-90x270: 7 / D-60x120: 14 / 120x120: 14 / 60x120: 14 / 90x90: 16 / 45x90: 32 / 60x60: 28 / 30x60: 56

**3D-Fit®**  
Technology

Natural Finish  
Escala 1/4

Available Colours:

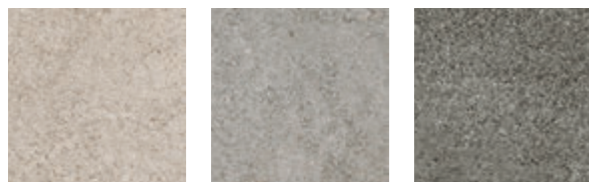

\*Kovo Light      \*Kovo Silver      Kovo Dark Grey

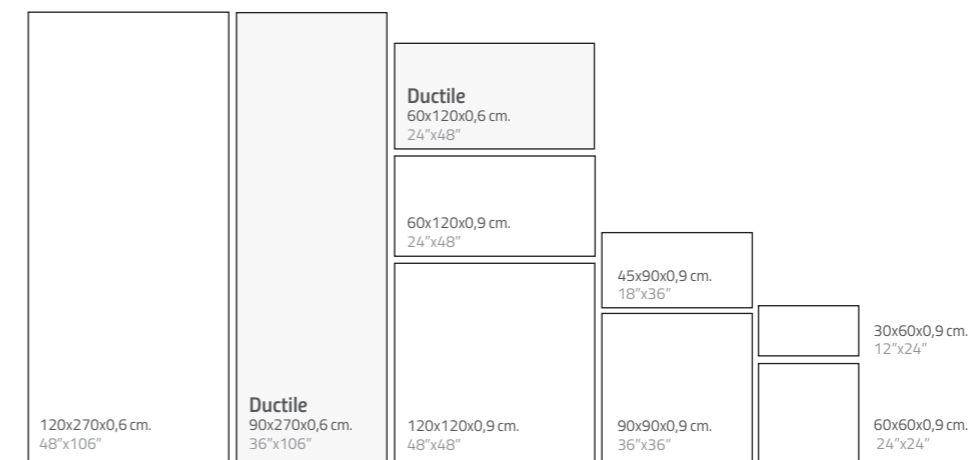

\*20mm. Thickness Available Colour  
\*Color Disponible en 20mm.

Available Sizes / Formatos Disponibles

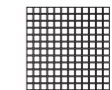
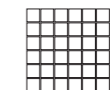
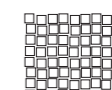

Complements / Complementos

Step Tile & Countertops Availables. Pag. 124.  
Peldaños y Encimeras disponibles. Pag. 124.

-  **Mosaic 25**  
Net 12"x12"  
Malla 30x30 cm.  
Real 29,8x29,8 cm.
-  **Mosaic 55**  
Net 12"x12"  
Malla 30x30 cm.  
Real 29,8x29,8 cm.
-  **Moved Mosaic**  
Net 12"x12"  
Malla 30x30 cm.  
Real 29,8x29,8 cm.
-  **Mureto Mosaic**  
Net 12"x18"  
Malla 30x45 cm.  
Real 29,8x29,8 cm.

Ductile Wall Tiles Available Sizes & Finishes / Formatos y Acabados Disponibles en Revestimientos Ductile

Nominal Size Formato Nominal	Real Size Formato Real	Natural Natural	Price Code Código Precio	Pz/Box	M2/Box	Kg/Box	Box/Pa	M2/Pa	Kg/Pa
Ductile 60x120 cm. 24"x48"	59,8x119,8x0,6 cm.	●	620	3	2,15	25,80	24	51,48	649
Ductile 90x270 cm. 36"x106"	89,8x269,8x0,6 cm.	●	970	1	2,42	29,04	24	58,08	801

Porcelain Tiles Available Sizes & Finishes / Formatos y Acabados Disponibles en Porcelánico

Nominal Size Formato Nominal	Real Size Formato Real	Natural C1 · R9 · CA	Anti-Slip Antideslizante C3 · R11 · CC	Price Code Código Precio	Pz/Box	M2/Box	Kg/Box	Box/Pa	M2/Pa	Kg/Pa
30x60 cm. 12"x24"	29,8x59,8x0,9 cm.	●	●	30	6	1,07	22,00	48	51,36	1094
60x60 cm. 24"x24"	59,8x59,8x0,9 cm.	●	●	60	3	1,07	23,22	40	42,91	962
45x90 cm. 18"x36"	44,8x89,8x0,9 cm.	●	●	45	3	1,21	25,50	32	38,62	849
90x90 cm. 36"x36"	89,8x89,8x0,9 cm.	●	●	90	2	1,61	34,00	24	38,71	846
*90x90x2 cm. 36"x36"	89,8x89,8x2 cm.	●	●	94	1	0,81	37,09	24	19,35	946
60x120 cm. 24"x48"	59,8x119,8x0,9 cm.	●	●	62	2	1,43	30,32	24	34,32	767
*120x120x2 cm. 48"x48"	119,8x119,8x2 cm.	●	●	121	1	1,44	66,02	16	22,96	1140
120x120 cm. 48"x48"	119,8x119,8x0,9 cm.	●	●	120	1	1,44	30,50	40	57,41	1265
120x270 cm. 48"x106"	119,8x269,8x0,6 cm.	●	●	276	1	3,23	45,50	24	77,52	1250
Mosaic 25	29,8x29,8x0,9 cm.	●	●	25	5	0,44	9,00	60	26,40	576
Mosaic 55	29,8x29,8x0,9 cm.	●	●	55	5	0,44	9,00	60	26,40	576
Moved Mosaic	29,8x29,8x0,9 cm.	●	●	302	5	0,44	9,00	60	26,40	576
Mureto Mosaic	29,8x29,8x0,9 cm.	●	●	300	5	0,44	9,00	40	17,60	395



Natural Finish      Anti-slip Finish

Color Body Porcelain / Porcelánico Masa Coloreada  
Rectified / Destonified V.3 / Rectificado / Destonificado V.3  
N° Designs By Format / N° De Diseños Por Formato :  
20x180: 42 / 20x120: 42 / 15x90: 72

Natural Finish  
Escala 1/4

Available Sizes / Formatos Disponibles



20x120x0,9 cm.  
8"x48"



20x180x0,9 cm.  
8"x72"



15x90x1,1 cm.  
6"x36"



Spike Left 15x90x1,1 cm.  
6"x36"

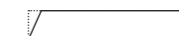

Spike Right 15x90x1,1 cm.  
6"x36"

Complements / Complementos

Step Tile & Countertops Availables. Pag. 124.  
Peldaños y Encimeras disponibles. Pag. 124.



Mosaic 330  
Net 12"x12"  
Malla 30x30 cm.  
Real 29,8x29,8 cm.

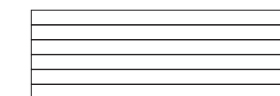

Mosaic 590  
Net 12"x36"  
Malla 30x90 cm.  
Real 29,8x89,8 cm.

Available Colours / Colores Disponibles



Lightwood White      Lightwood Sand      Lightwood Canella      Lightwood Cognac      Lightwood Ash      Lightwood Brown

Porcelain Tiles Available Sizes & Finishes / Formatos y Acabados Disponibles en Porcelánico

Nominal Size Formato Nominal	Real Size Formato Real	Natural Natural C1 · R9 · CA	Anti-Slip Antideslizante C3 · R11 · CC	Price Code Código Precio	Pz/Box	M2/Box	Kg/Box	Box/Pa	M2/Pa	Kg/Pa
15x90 cm. 6"x36"	14,8x89,8x1,1 cm.	●		15	7	0,93	20,30	48	44,64	998
Spike 15x90 cm. 6"x36"	14,8x81,0x1,1 cm.	●		16	7	0,84	17,50	48	38,88	864
20x120 cm. 8"x48"	19,8x119,8x0,9 cm.	●	●	20	5	1,19	25,15	45	53,55	1165
20x180 cm. 8"x72"	19,8x179,8x0,9 cm.	●		21	3	1,07	22,11	48	51,36	1061
Mosaic 330	29,8x29,8x0,9 cm.	●		330	5	0,44	10,50	60	26,40	666
Mosaic 590	29,8x89,8x0,9 cm.	●		590	3	0,81	18,30	20	16,20	398



Natural Finish      Anti-slip Finish

Color Body Porcelain & Ductile / Porcelánico Masa Coloreada y Ductile  
Rectified / Destonified V.2 / Rectificada / Destonificado V.2  
N° Designs By Format / N° De Diseños Por Formato :  
120x270: 7 / D-90x270: 7 / D-60x120: 14 / 120x120: 14 / 60x120: 14 / 90x90: 16 / 45x90: 32 / 60x60: 28 / 30x60: 56

**3D-Fit®**  
Technology

Natural Finish  
Escala 1/4

Available Sizes / Formatos Disponibles

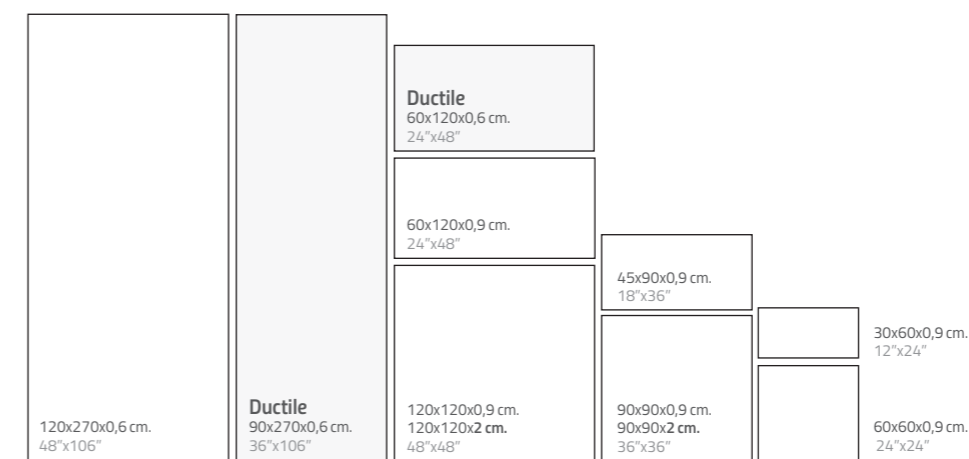

Complements / Complementos

Step Tile & Countertops Availables. Pag. 124.  
Peldaños y Encimeras disponibles. Pag. 124.



**Deco Mosaic**  
Net 24"x24"  
Malla 60x60 cm.  
Real 59,8x59,8 cm.



**Mosaic 25**  
Net 12"x12"  
Malla 30x30 cm.  
Real 29,8x29,8 cm.



**Mosaic 55**  
Net 12"x12"  
Malla 30x30 cm.  
Real 29,8x29,8 cm.



**Mosaic 315**  
Net 12"x12"  
Malla 30x30 cm.  
Real 29,8x29,8 cm.



**Mureto Mosaic**  
Net 12"x18"  
Malla 30x45 cm.  
Real 29,8x29,8 cm.

Ductile Wall Tiles Available Sizes & Finishes / Formatos y Acabados Disponibles en Revestimientos Ductile

Nominal Size Formato Nominal	Real Size Formato Real	Natural Natural	Price Code Código Precio	Pz/Box	M2/Box	Kg/Box	Box/Pa	M2/Pa	Kg/Pa
Ductile 60x120 cm. 24"x48"	59,8x119,8x0,6 cm.	●	620	3	2,15	25,80	24	51,48	649
Ductile 90x270 cm. 36"x106"	89,8x269,8x0,6 cm.	●	970	1	2,42	29,04	24	58,08	801

Porcelain Tiles Available Sizes & Finishes / Formatos y Acabados Disponibles en Porcelánico

Nominal Size Formato Nominal	Real Size Formato Real	Natural Natural C1 · R9 · CA	Anti-Slip Antideslizante C3 · R11 · CC	Price Code Código Precio	Pz/Box	M2/Box	Kg/Box	Box/Pa	M2/Pa	Kg/Pa
30x60 cm. 12"x24"	29,8x59,8x0,9 cm.	●	●	30	6	1,07	22,00	48	51,36	1094
60x60 cm. 24"x24"	59,8x59,8x0,9 cm.	●	●	60	3	1,07	23,22	40	42,91	962
45x90 cm. 18"x36"	44,8x89,8x0,9 cm.	●	●	45	3	1,21	25,50	32	38,62	849
90x90 cm. 36"x36"	89,8x89,8x0,9 cm.	●	●	90	2	1,61	34,00	24	38,71	846
*90x90x2 cm. 36"x36"	89,8x89,8x2 cm.	●	●	94	1	0,81	37,09	24	19,35	946
60x120 cm. 24"x48"	59,8x119,8x0,9 cm.	●	●	62	2	1,43	30,32	24	34,32	767
120x120 cm. 48"x48"	119,8x119,8x0,9 cm.	●	●	120	1	1,44	30,50	40	57,41	1265
*120x120x2 cm. 48"x48"	119,8x119,8x2 cm.	●	●	121	1	1,44	66,02	16	22,96	1140
120x270 cm. 48"x106"	119,8x269,8x0,6 cm.	●	●	276	1	3,23	45,50	24	77,52	1250
Mosaic 25	29,8x29,8x0,9 cm.	●	●	25	5	0,44	9,00	60	26,40	576
Mosaic 55	29,8x29,8x0,9 cm.	●	●	55	5	0,44	9,00	60	26,40	576
Mosaic 315	29,8x29,8x0,9 cm.	●	●	315	5	0,44	9,00	60	26,40	576
Mureto Mosaic	29,8x29,8x0,9 cm.	●	●	300	5	0,44	9,00	40	17,60	395
Deco Mosaic	59,8x59,8x0,9 cm.	●	●	560	4	0,92	20,00	24	22,10	510

Available Colours:

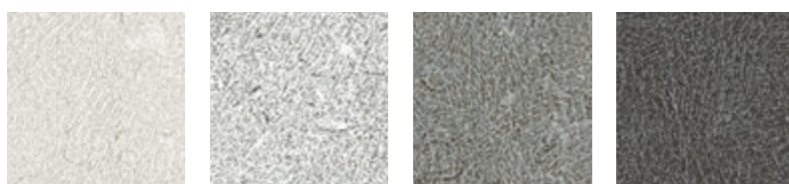

\*Noon Sand      \*Noon Grey      Noon Dark Grey      Noon Anthracite

\*20mm. Thickness Available Colour  
\*Color Disponible en 20mm.





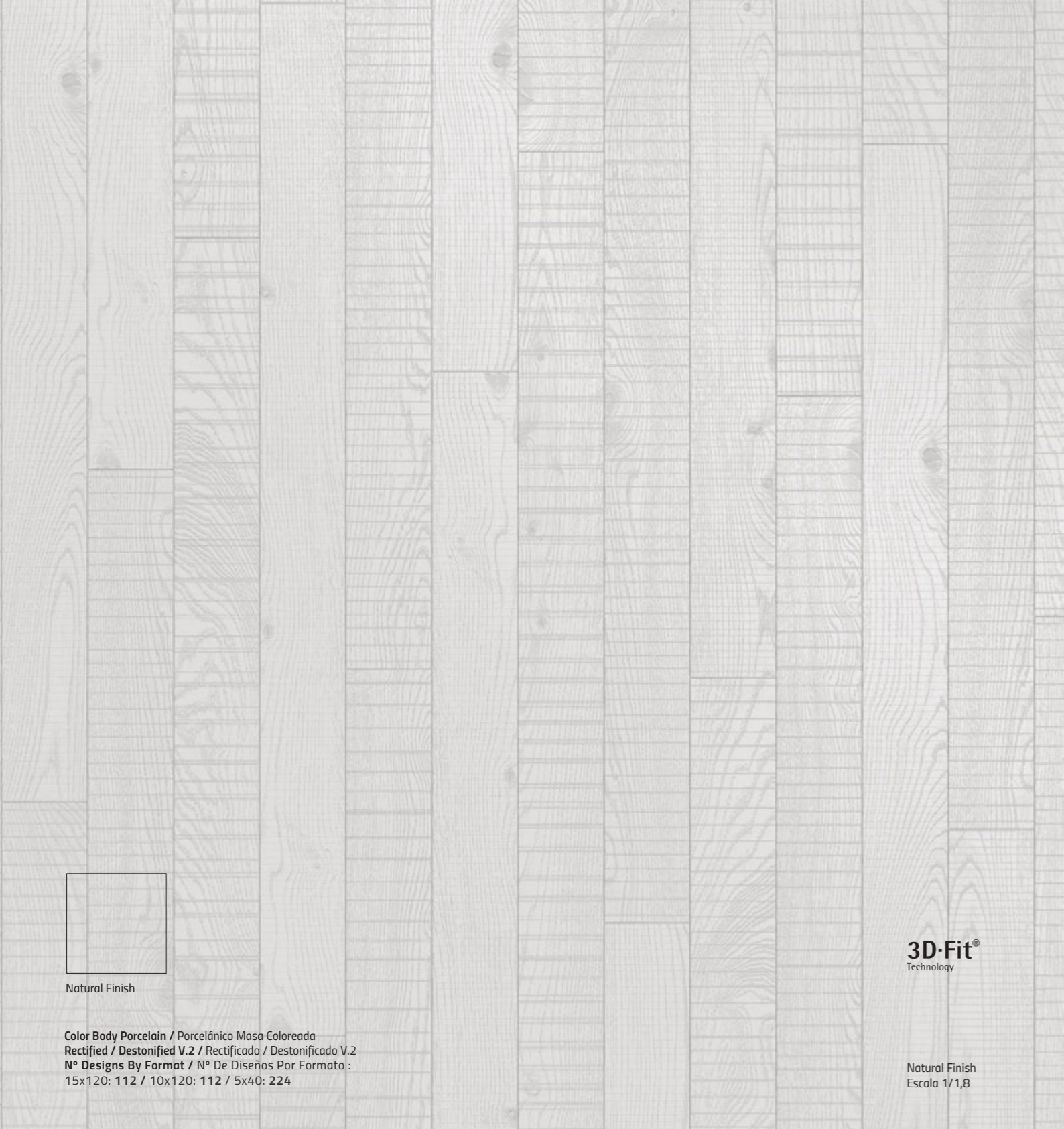

Natural Finish

Color Body Porcelain / Porcelánico Masa Coloreada  
Rectified / Destonified V.2 / Rectificado / Destonificado V.2  
N° Designs By Format / N° De Diseños Por Formato :  
15x120: 112 / 10x120: 112 / 5x40: 224

**3D-Fit®**  
Technology

Natural Finish  
Escala 1/1,8

Available Sizes / Formatos Disponibles



5x40x0,9 cm.  
2"x16"



10x120x0,9 cm.  
4"x48"



15x120x0,9 cm.  
6"x48"

Available Colours / Colores Disponibles



Rem White

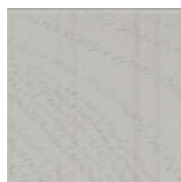

Rem Soft Grey

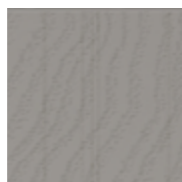

Rem Grey

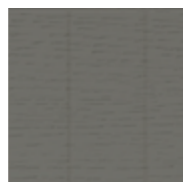

Rem Taupe



Rem Black

Porcelain Tiles Available Sizes & Finishes / Formatos y Acabados Disponibles en Porcelánico

Nominal Size Formato Nominal	Real Size Formato Real	Natural Natural C2 · R10 · CB	Price Code Código Precio	Pz/Box	M2/Box	Kg/Box	Box/Pa	M2/Pa	Kg/Pa
5x40 cm. 2"x16"	4,8x39,8x0,9 cm.	●	6	50	0,95	19,77	50	47,5	989
10x120 cm. 4"x48"	9,8x119,8x0,9 cm.	●	19	9	1,057	21,87	48	43,2	1050
15x120 cm. 6"x48"	14,8x119,8x0,9 cm.	●	18	6	1,064	22,02	48	51,07	1057

# Uno

Oak in Ceramics  
Roble en Cerámica

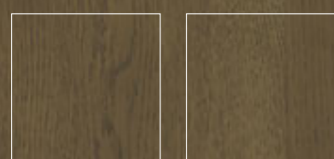

Natural Finish      Anti-slip Finish

Color Body Porcelain / Porcelánico Masa Coloreada  
Rectified / Destonified V.3 / Rectificado / Destonificado V.3  
N° Designs By Format / N° De Diseños Por Formato :  
22,5x200: 21 / 22,5x160: 39 / 20x120: 39

**3D-Fit®**  
Technology

Natural Finish  
Escala 1/4

## Available Sizes / Formatos Disponibles



20x120x0,9 cm.  
8"x48"



22,5x160x0,9 cm.  
9"x63"



22,5x200x0,9 cm.  
9"x79"

## Complements / Complementos

Step Tile & Countertops Availables. Pag. 124.  
Peldaños y Encimeras disponibles. Pag. 124.



Mosaic 330  
Net 12"x12"  
Malla 30x30 cm.  
Real 29,8x29,8 cm.

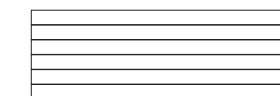

Mosaic 590  
Net 12"x36"  
Malla 30x90 cm.  
Real 29,8x89,8 cm.

## Available Colours / Colores Disponibles



Uno Sand      Uno Canela      Uno Cognac      Uno Walnut      Uno Cocoa      Uno Nightfall

## Porcelain Tiles Available Sizes & Finishes / Formatos y Acabados Disponibles en Porcelánico

Nominal Size Formato Nominal	Real Size Formato Real	Natural Natural C2 · R10 · CB	Anti-Slip Antideslizante C3 · R11 · CC	Price Code Código Precio	Pz/Box	M2/Box	Kg/Box	Box/Pa	M2/Pa	Kg/Pa
20x120 cm. 8"x48"	19,8x119,8x0,9 cm.	●	●	20	5	1,19	25,15	45	53,55	1165
22,5x160 cm. 9"x63"	22,3x159,8x0,9 cm.	●	●	23	3	1,06	22,13	54	57,72	1230
22,5x200 cm. 9"x79"	22,3x199,8x0,9 cm.	●	●	22	3	1,33	27,69	42	56,14	1163
Mosaic 330	29,8x29,8x0,9 cm.	●	●	330	5	0,44	10,50	60	26,40	666
Mosaic 590	29,8x89,8x0,9 cm.	●	●	590	3	0,81	18,30	20	16,20	398



Honed Finish    Natural Finish    B.H. Finish    B.H. Anti-Slip Finish

**Color Body Porcelain & Ductile / Porcelánico Masa Coloreada y Ductile**  
**Rectified / Destonified V.2 / Rectificado / Destonificado V.2**  
**N° Designs By Format / N° De Diseños Por Formato :**  
120x270: 7 / D-90x270: 7 / D-60x120: 24 / 120x120: 14 / 60x120: 24 / 90x90: 16 / 45x90: 32 / 60x60: 48 / 30x60: 96

**3D-Fit®**  
Technology

Natural Finish  
Escala 1/4

**Available Colours / Colores Disponibles**

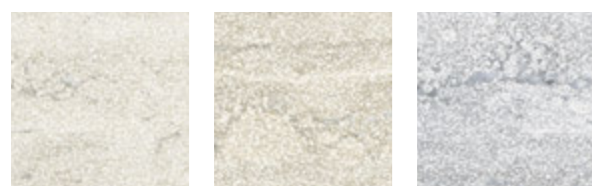

\*Verso Vein Cut Light    \*Verso Vein Cut Classic    Verso Vein Cut Grey

\*20mm. Thickness Available Colour  
\*Color Disponible en 20mm.

**Available Sizes / Formatos Disponibles**

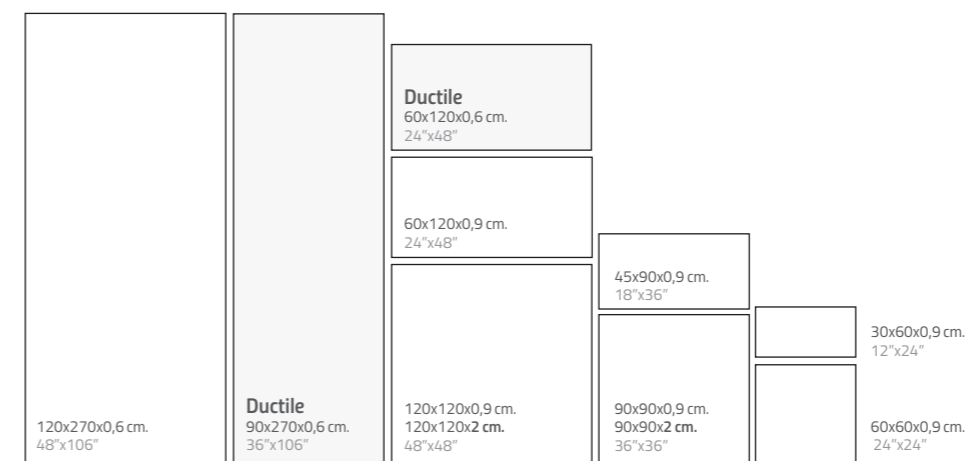

**Complements / Complementos**

Step Tile & Countertops Availables. Pag. 124.  
Peldaños y Encimeras disponibles. Pag. 124.



**Mosaic 25**  
Net 12"x12"  
Malla 30x30 cm.  
Real 29,8x29,8 cm.



**Mosaic 55**  
Net 12"x12"  
Malla 30x30 cm.  
Real 29,8x29,8 cm.



**Mureto Mosaic**  
Net 12"x18"  
Malla 30x45 cm.  
Real 29,8x29,8 cm.

**Ductile Wall Tiles Available Sizes & Finishes / Formatos y Acabados Disponibles en Revestimientos Ductile**

Nominal Size Formato Nominal	Real Size Formato Real	Natural Natural	Price Code Código Precio	Pz/Box	M2/Box	Kg/Box	Box/Pa	M2/Pa	Kg/Pa
Ductile 60x120 cm. 24"x48"	59,8x119,8x0,6 cm.	●	620	3	2,15	25,80	24	51,48	649
Ductile 90x270 cm. 36"x106"	89,8x269,8x0,6 cm.	●	970	1	2,42	29,04	24	58,08	801

**Porcelain Tiles Available Sizes & Finishes / Formatos y Acabados Disponibles en Porcelánico**

Nominal Size Formato Nominal	Real Size Formato Real	Honed Apomazado	Natural Natural C2-R10-CB	B.Hammered Abujardado C2-R10-CB	B. H. Anti-Slip Abujardado AS C3-R11-CC	Price Code Código Precio	Pz/Box	M2/Box	Kg/Box	Box/Pa	M2/Pa	Kg/Pa
30x60 cm. 12"x24"	29,8x59,8x0,9 cm.	●	●		●	30 / 30H	6	1,07	22,00	48	51,36	1094
60x60 cm. 24"x24"	59,8x59,8x0,9 cm.	●	●		●	60 / 60H	3	1,07	23,22	40	42,91	962
45x90 cm. 18"x36"	44,8x89,8x0,9 cm.	●	●		●	45 / 45H	3	1,21	25,50	32	38,62	849
90x90 cm. 36"x36"	89,8x89,8x0,9 cm.	●	●		●	90 / 90H	2	1,61	34,00	24	38,71	846
*90x90x2 cm. 36"x36"	89,8x89,8x2 cm.				●	94	1	0,81	37,09	24	19,35	946
60x120 cm. 24"x48"	59,8x119,8x0,9 cm.	●	●		●	62 / 62H	2	1,43	30,32	24	34,32	767
120x120 cm. 48"x48"	119,8x119,8x0,9 cm.	●	●		●	120 / 120H	1	1,44	30,50	40	57,41	1265
*120x120x2 cm. 48"x48"	119,8x119,8x2 cm.				●	121	1	1,44	66,02	16	22,96	1140
120x270 cm. 48"x106"	119,8x269,8x0,6 cm.	●	●	●		276 / 276H	1	3,23	45,50	24	77,52	1250
Mosaic 25	29,8x29,8x0,9 cm.	●	●		●	25 / 25H	5	0,44	9,00	60	26,40	576
Mosaic 55	29,8x29,8x0,9 cm.	●	●		●	55 / 55H	5	0,44	9,00	60	26,40	576
Mureto Mosaic	29,8x29,8x0,9 cm.	●	●		●	300 / 300H	5	0,44	9,00	40	17,60	395

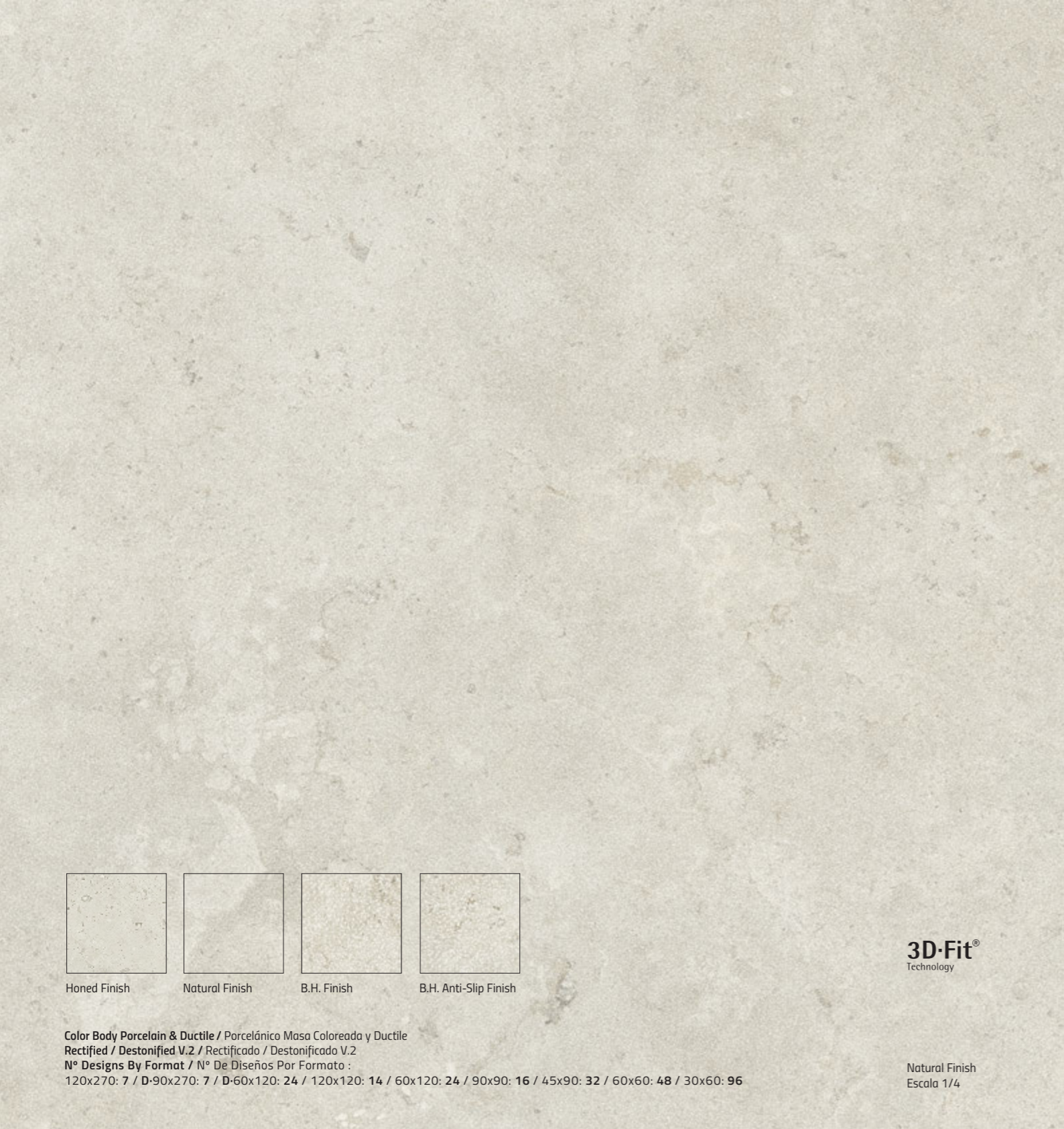

Honed Finish    Natural Finish    B.H. Finish    B.H. Anti-Slip Finish

**Color Body Porcelain & Ductile / Porcelánico Masa Coloreada y Ductile**  
**Rectified / Destonified V.2 / Rectificado / Destonificado V.2**  
**N° Designs By Format / N° De Diseños Por Formato :**  
120x270: **7** / D-90x270: **7** / D-60x120: **24** / 120x120: **14** / 60x120: **24** / 90x90: **16** / 45x90: **32** / 60x60: **48** / 30x60: **96**

**3D-Fit®**  
Technology

Natural Finish  
Escala 1/4

**Available Colours / Colores Disponibles**

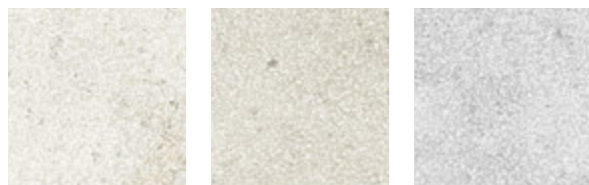

\*Verso Cross Cut Light    \*Verso Cross Cut Classic    Verso Cross Cut Grey

\*20mm. Thickness Available Colour  
\*Color Disponible en 20mm.

**Available Sizes / Formatos Disponibles**

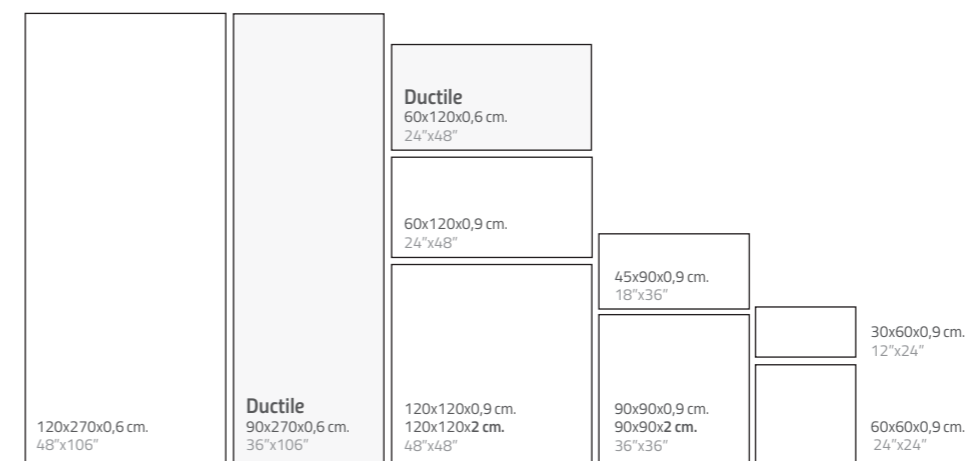

**Complements / Complementos**

Step Tile & Countertops Availables. Pag. 124.  
Peldaños y Encimeras disponibles. Pag. 124.



**Mosaic 25**  
Net 12"x12"  
Malla 30x30 cm.  
Real 29,8x29,8 cm.



**Mosaic 55**  
Net 12"x12"  
Malla 30x30 cm.  
Real 29,8x29,8 cm.



**Mureto Mosaic**  
Net 12"x18"  
Malla 30x45 cm.  
Real 29,8x29,8 cm.

**Ductile Wall Tiles Available Sizes & Finishes / Formatos y Acabados Disponibles en Revestimientos Ductile**

Nominal Size Formato Nominal	Real Size Formato Real	Natural Natural	Price Code Código Precio	Pz/Box	M2/Box	Kg/Box	Box/Pa	M2/Pa	Kg/Pa
Ductile 60x120 cm. 24"x48"	59,8x119,8x0,6 cm.	●	620	3	2,15	25,80	24	51,48	649
Ductile 90x270 cm. 36"x106"	89,8x269,8x0,6 cm.	●	970	1	2,42	29,04	24	58,08	801

**Porcelain Tiles Available Sizes & Finishes / Formatos y Acabados Disponibles en Porcelánico**

Nominal Size Formato Nominal	Real Size Formato Real	Honed Apomazado	Natural Natural C2-R10-CB	B.Hammered Abujardado C2-R10-CB	B. H. Anti-Slip Abujardado AS C3-R11-CC	Price Code Código Precio	Pz/Box	M2/Box	Kg/Box	Box/Pa	M2/Pa	Kg/Pa
30x60 cm. 12"x24"	29,8x59,8x0,9 cm.	●	●		●	30 / 30H	6	1,07	22,00	48	51,36	1094
60x60 cm. 24"x24"	59,8x59,8x0,9 cm.	●	●		●	60 / 60H	3	1,07	23,22	40	42,91	962
45x90 cm. 18"x36"	44,8x89,8x0,9 cm.	●	●		●	45 / 45H	3	1,21	25,50	32	38,62	849
90x90 cm. 36"x36"	89,8x89,8x0,9 cm.	●	●		●	90 / 90H	2	1,61	34,00	24	38,71	846
*90x90x2 cm. 36"x36"	89,8x89,8x2 cm.				●	94	1	0,81	37,09	24	19,35	946
60x120 cm. 24"x48"	59,8x119,8x0,9 cm.	●	●		●	62 / 62H	2	1,43	30,32	24	34,32	767
120x120 cm. 48"x48"	119,8x119,8x0,9 cm.	●	●		●	120 / 120H	1	1,44	30,50	40	57,41	1265
*120x120x2 cm. 48"x48"	119,8x119,8x2 cm.				●	121	1	1,44	66,02	16	22,96	1140
120x270 cm. 48"x106"	119,8x269,8x0,6 cm.	●	●	●		276 / 276H	1	3,23	45,50	24	77,52	1250
Mosaic 25	29,8x29,8x0,9 cm.	●	●		●	25 / 25H	5	0,44	9,00	60	26,40	576
Mosaic 55	29,8x29,8x0,9 cm.	●	●		●	55 / 55H	5	0,44	9,00	60	26,40	576
Mureto Mosaic	29,8x29,8x0,9 cm.	●	●		●	300 / 300H	5	0,44	9,00	40	17,60	395

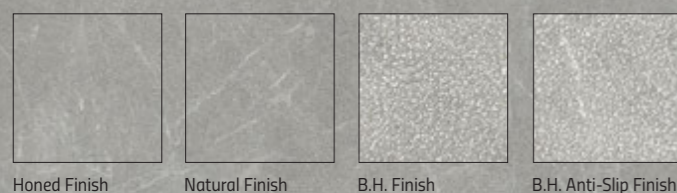
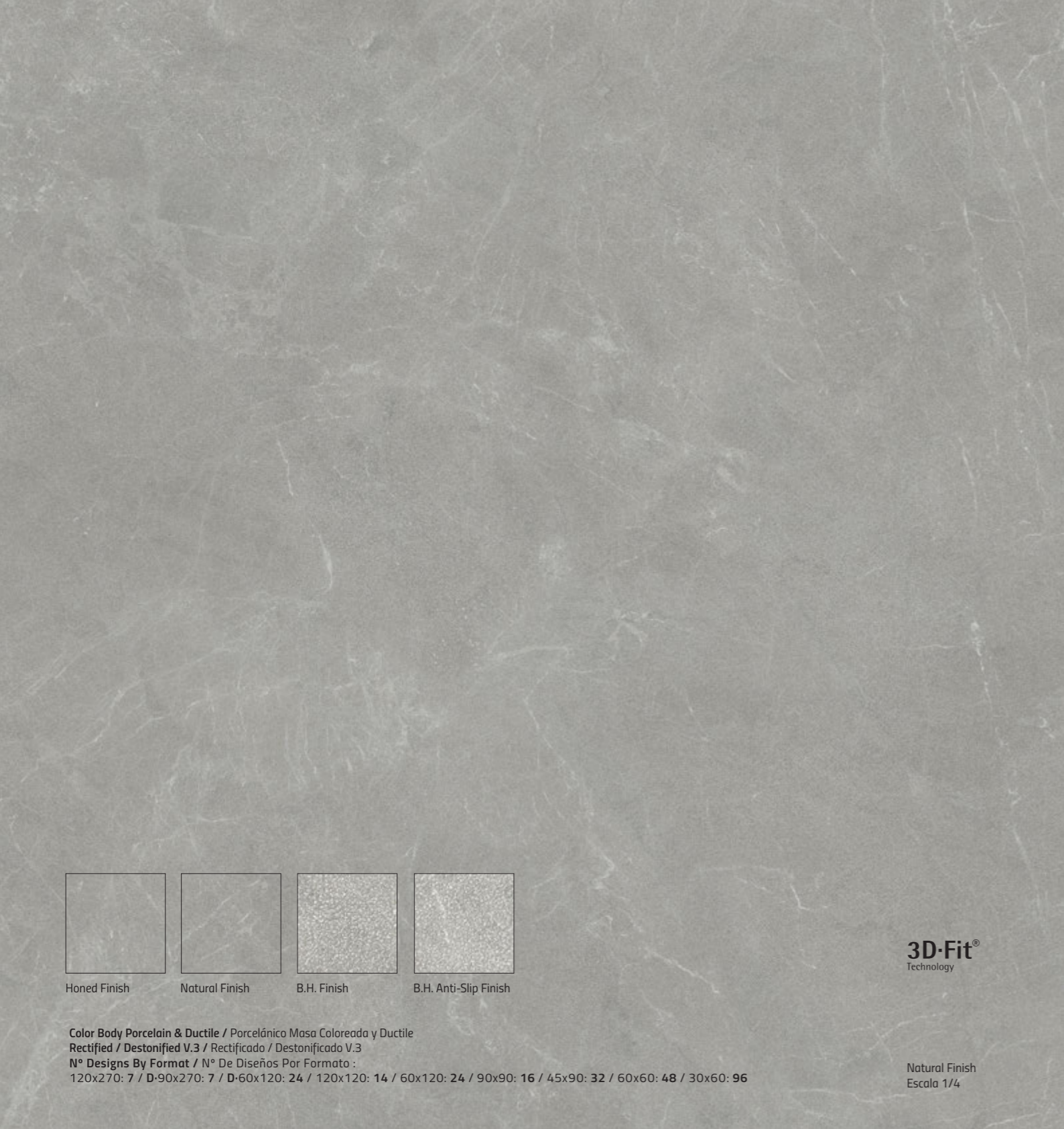

Honed Finish    Natural Finish    B.H. Finish    B.H. Anti-Slip Finish

Color Body Porcelain & Ductile / Porcelánico Masa Coloreada y Ductile  
Rectified / Destonified V.3 / Rectificado / Destonificado V.3  
N° Designs By Format / N° De Diseños Por Formato :

120x270: 7 / D-90x270: 7 / D-60x120: 24 / 120x120: 14 / 60x120: 24 / 90x90: 16 / 45x90: 32 / 60x60: 48 / 30x60: 96

**3D-Fit®**  
Technology

Natural Finish  
Escala 1/4

Available Colours:

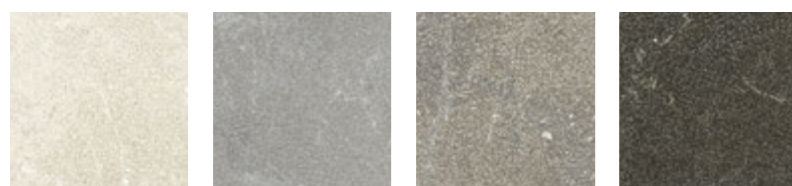

\*Vonn Light    \*Vonn Grey    Vonn Greige    \*Vonn Anthracite

\*20mm. Thickness Available Colour  
\*Color Disponible en 20mm.

Available Sizes / Formatos Disponibles

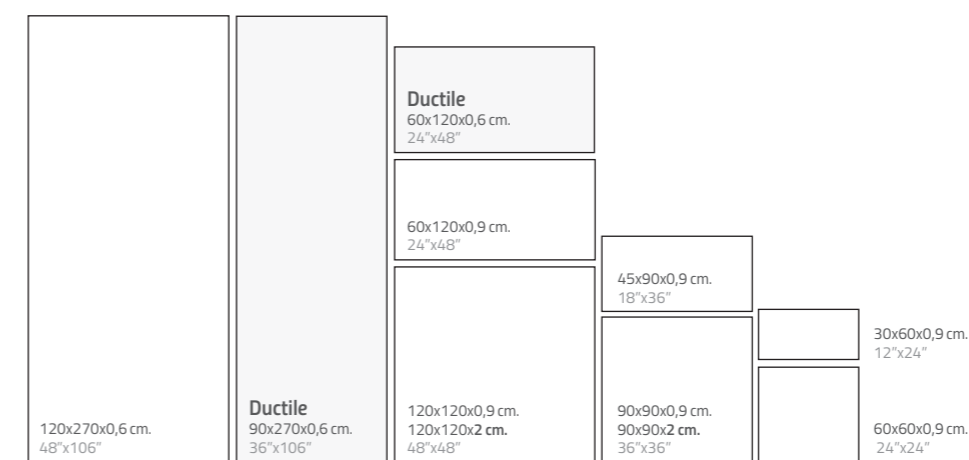

Complements / Complementos

Step Tile & Countertops Availables. Pag. 124.  
Peldaños y Encimeras disponibles. Pag. 124.

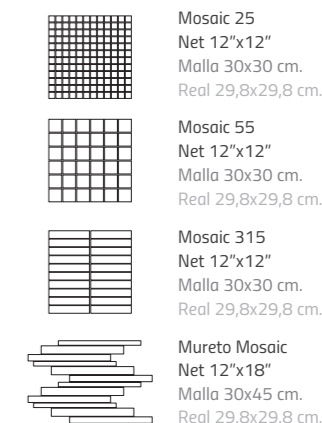

**Mosaic 25**  
Net 12"x12"  
Malla 30x30 cm.  
Real 29,8x29,8 cm.

**Mosaic 55**  
Net 12"x12"  
Malla 30x30 cm.  
Real 29,8x29,8 cm.

**Mosaic 315**  
Net 12"x12"  
Malla 30x30 cm.  
Real 29,8x29,8 cm.

**Mureto Mosaic**  
Net 12"x18"  
Malla 30x45 cm.  
Real 29,8x29,8 cm.

Ductile Wall Tiles Available Sizes & Finishes / Formatos y Acabados Disponibles en Revestimientos Ductile

Nominal Size Formato Nominal	Real Size Formato Real	Natural Natural	Price Code Código Precio	Pz/Box	M2/ Box	Kg/Box	Box/Pa	M2/Pa	Kg/Pa
Ductile 60x120 cm. 24"x48"	59,8x119,8x0,6 cm.	●	620	3	2,15	25,80	24	51,48	649
Ductile 90x270 cm. 36"x106"	89,8x269,8x0,6 cm.	●	970	1	2,42	29,04	24	58,08	801

Porcelain Tiles Available Sizes & Finishes / Formatos y Acabados Disponibles en Porcelánico

Nominal Size Formato Nominal	Real Size Formato Real	Honed Apomazado	Natural C2 · R10 · CB	B.Hammered Abujardado C2 · R10 · CB	B. H. Anti-Slip Abujardado AS C3 · R11 · CC	Price Code Código Precio	Pz/Box	M2/ Box	Kg/Box	Box/Pa	M2/Pa	Kg/Pa
30x60 cm. 12"x24"	29,8x59,8x0,9 cm.	●	●		●	30 / 30H	6	1,07	22,00	48	51,36	1094
60x60 cm. 24"x24"	59,8x59,8x0,9 cm.	●	●		●	60 / 60H	3	1,07	23,22	40	42,91	962
45x90 cm. 18"x36"	44,8x89,8x0,9 cm.	●	●		●	45 / 45H	3	1,21	25,50	32	38,62	849
90x90 cm. 36"x36"	89,8x89,8x0,9 cm.	●	●		●	90 / 90H	2	1,61	34,00	24	38,71	846
*90x90x2 cm. 36"x36"	89,8x89,8x2 cm.				●	94	1	0,81	37,09	24	19,35	946
60x120 cm. 24"x48"	59,8x119,8x0,9 cm.	●	●		●	62 / 62H	2	1,43	30,32	24	34,32	767
120x120 cm. 48"x48"	119,8x119,8x0,9 cm.	●	●		●	120 / 120H	1	1,44	30,50	40	57,41	1265
*120x120x2 cm. 48"x48"	119,8x119,8x2 cm.				●	121	1	1,44	66,02	16	22,96	1140
120x270 cm. 48"x106"	119,8x269,8x0,6 cm.	●	●	●		276 / 276H	1	3,23	45,50	24	77,52	1250
Mosaic 25	29,8x29,8x0,9 cm.	●	●		●	25 / 25H	5	0,44	9,00	60	26,40	576
Mosaic 55	29,8x29,8x0,9 cm.	●	●		●	55 / 55H	5	0,44	9,00	60	26,40	576
Mosaic 315	29,8x29,8x0,9 cm.	●	●		●	315	5	0,44	9,00	60	26,40	576
Mureto Mosaic	29,8x29,8x0,9 cm.	●	●		●	300 / 300H	5	0,44	9,00	40	17,60	395



Natural Finish      Anti-slip Finish

**3D-Fit**  
Technology

Color Body Porcelain & Ductile / Porcelánico Masa Coloreada y Ductile  
Rectified / Destonified V.2 / Rectificado / Destonificado V.2  
N° Designs By Format / N° De Diseños Por Formato :  
120x270: 7 / D-90x270: 7 / D-60x120: 14 / 120x120: 14 / 60x120: 14 / 90x90: 16 / 45x90: 32 / 60x60: 28 / 30x60: 56

Natural Finish  
Escala 1/4

Available Colours:

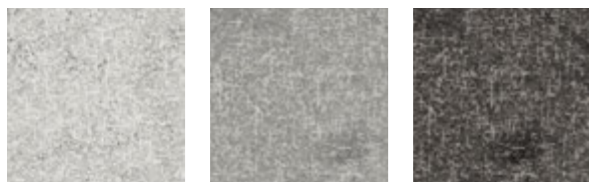

Wam Light      Wam Grey      Wam Anthracite

Available Sizes / Formatos Disponibles

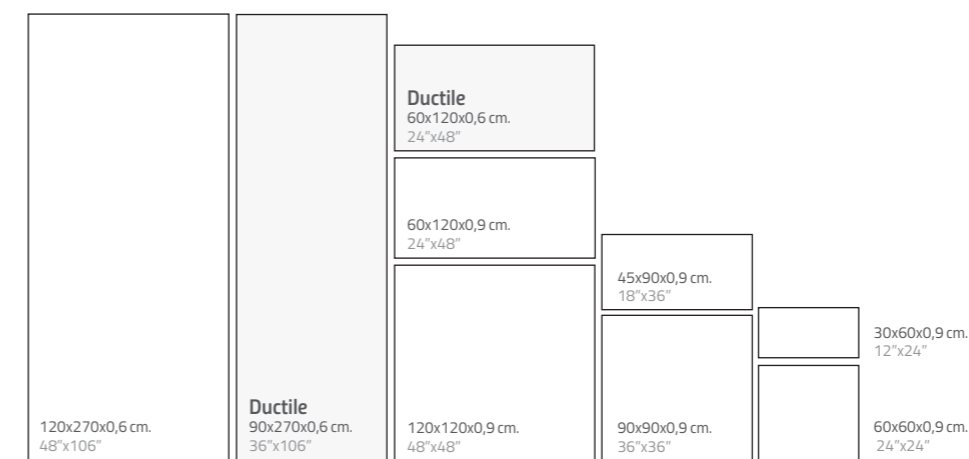

Complements / Complementos

Step Tile & Countertops Availables. Pag. 124.  
Peldaños y Encimeras disponibles. Pag. 124.



Mosaic 25  
Net 12"x12"  
Malla 30x30 cm.  
Real 29,8x29,8 cm.



Mosaic 55  
Net 12"x12"  
Malla 30x30 cm.  
Real 29,8x29,8 cm.



Spike Mosaic  
Net 12"x18"  
Malla 30x45 cm.  
Real 22,6x43 cm.

Ductile Wall Tiles Available Sizes & Finishes / Formatos y Acabados Disponibles en Revestimientos Ductile

Nominal Size Formato Nominal	Real Size Formato Real	Natural Natural	Price Code Código Precio	Pz/Box	M2/Box	Kg/Box	Box/Pa	M2/Pa	Kg/Pa
Ductile 60x120 cm. 24"x48"	59,8x119,8x0,6 cm.	●	620	3	2,15	25,80	24	51,48	649
Ductile 90x270 cm. 36"x106"	89,8x269,8x0,6 cm.	●	970	1	2,42	29,04	24	58,08	801

Porcelain Tiles Available Sizes & Finishes / Formatos y Acabados Disponibles en Porcelánico

Nominal Size Formato Nominal	Real Size Formato Real	Natural Natural C1 · R9 · CA	Anti-Slip Antideslizante C3 · R11 · CC	Price Code Código Precio	Pz/Box	M2/Box	Kg/Box	Box/Pa	M2/Pa	Kg/Pa
30x60 cm. 12"x24"	29,8x59,8x0,9 cm.	●	●	30	6	1,07	22,00	48	51,36	1094
60x60 cm. 24"x24"	59,8x59,8x0,9 cm.	●	●	60	3	1,07	23,22	40	42,91	962
45x90 cm. 18"x36"	44,8x89,8x0,9 cm.	●	●	45	3	1,21	25,50	30	36,21	832
90x90 cm. 36"x36"	89,8x89,8x0,9 cm.	●	●	90	2	1,61	34,00	24	38,71	846
60x120 cm. 24"x48"	59,8x119,8x0,9 cm.	●	●	62	2	1,43	30,32	24	34,32	728
120x120 cm. 48"x48"	119,8x119,8x0,9 cm.	●	●	120	1	1,44	30,50	40	57,41	1265
120x270 cm. 48"x106"	119,8x269,8x0,6 cm.	●	●	276	1	3,23	45,50	24	77,52	1250
Mosaic 25	29,8x29,8x0,9 cm.	●	●	25	5	0,44	9,02	60	26,40	565
Mosaic 55	29,8x29,8x0,9 cm.	●	●	55	5	0,44	9,02	60	26,40	565
Spike Mosaic	22,6x43	●	●	303	5	0,47	10,75	40	18,80	465



Natural Finish

Through-Body Porcelain / Porcelánico Técnico Todo Masa  
Rectified / Destonified V.2 / Rectificado / Destonificado V.2  
N° Designs By Format / N° De Diseños Por Formato :  
Unlimited designs by Format.

**3D-Fit**<sup>®</sup>  
Technology

**Corelith**<sup>®</sup>  
Technology

Natural Finish  
Escala 1/3

Through-Body Porcelain / Porcelánico Todo Masa

The full body porcelain tile delivers certain advantages vs other collections, without losing all benefits the glaze porcelain offers, its main feature resides in its inside. The raw material that shapes the tile become uniform without any superficial decoration that delivers the same aesthetic throughout the tile, this particularity make it the best fit for all those spaces that demand the most hard wearing materials.

La cerámica técnica de alto rendimiento confiere ciertas ventajas con respecto a otras colecciones. Sin dejar de ofrecer todos los beneficios de un Gres Porcelánico, su característica más evidente se encuentra en su interior. La masa cerámica que conforma la pieza pasa a ser uniforme y deja de utilizarse una decoración superficial, para conferir a toda la pieza el mismo aspecto, incluyendo laterales e interior. Esta particularidad lo hace idóneo para revestir espacios con alto tráfico peatonal sometidos a un gran desgaste y que necesiten de un pavimento que ofrezca las más altas garantías superficiales.

Available Sizes / Formatos Disponibles

Step Tile & Countertops Availables. Pag. 124.  
Peldaños y Encimeras disponibles. Pag. 124.

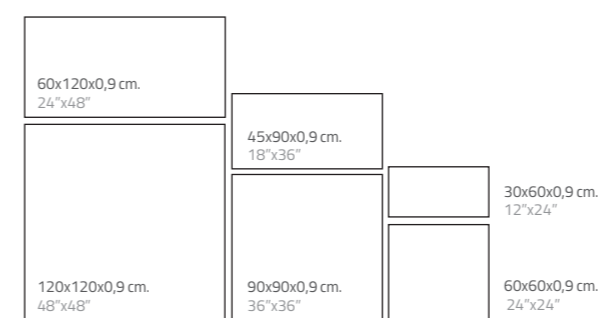

Available Colours:

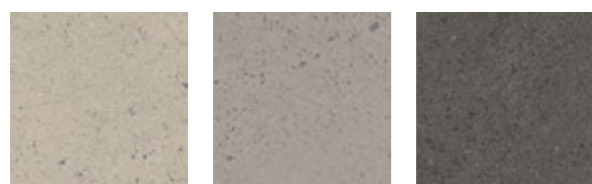

Kron Sand

Kron Grey

Kron Anthracite

Tech. Porcelain Tiles Available Sizes & Finishes / Formatos y Acabados Disponibles en Porcelánico Tec.

Nominal Size Formato Nominal	Real Size Formato Real	Natural Natural R10 - CB	Price Code Código Precio	Pz/Box	M2/Box	Kg/Box	Box/Pa	M2/Pa	Kg/Pa
30x60 cm. 12"x24"	29,8x59,8x0,9 cm.	●	30T	6	1,07	22,00	48	51,36	1094
60x60 cm. 24"x24"	59,8x59,8x0,9 cm.	●	60T	3	1,07	23,12	40	42,91	949
45x90 cm. 18"x36"	44,8x89,8x0,9 cm.	●	45T	3	1,21	25,50	30	36,21	832
90x90 cm. 36"x36"	89,8x89,8x0,9 cm.	●	90T	2	1,61	34,00	24	38,71	846
60x120 cm. 24"x48"	59,8x119,8x0,9 cm.	●	62T	2	1,43	30,32	24	34,32	728
120x120 cm. 48"x48"	119,8x119,8x0,9 cm.	●	120T	1	1,44	30,50	40	57,41	1265



Natural Finish

Through-Body Porcelain / Porcelánico Técnico Todo Masa  
 Rectified / Destonified V.2 / Rectificado / Destonificado V.2  
 N° Designs By Format / N° De Diseños Por Formato :  
 Unlimited designs by Format.

**3D-Fit**<sup>®</sup>  
 Technology

**Corelith**<sup>®</sup>  
 Technology

Natural Finish  
 Escala 1/3

Through-Body Porcelain / Porcelánico Todo Masa

The full body porcelain tile delivers certain advantages vs other collections, without losing all benefits the glaze porcelain offers, its main feature resides in its inside. The raw material that shapes the tile become uniform without any superficial decoration that delivers the same aesthetic throughout the tile, this particularity make it the best fit for all those spaces that demand the most hard wearing materials.

La cerámica técnica de alto rendimiento confiere ciertas ventajas con respecto a otras colecciones. Sin dejar de ofrecer todos los beneficios de un Gres Porcelánico, su característica más evidente se encuentra en su interior. La masa cerámica que conforma la pieza pasa a ser uniforme y deja de utilizarse una decoración superficial, para conferir a toda la pieza el mismo aspecto, incluyendo laterales e interior. Esta particularidad lo hace idóneo para revestir espacios con alto tráfico peatonal sometidos a un gran desgaste y que necesiten de un pavimento que ofrezca las más altas garantías superficiales.

Available Sizes / Formatos Disponibles

Step Tile & Countertops Availables. Pag. 124.  
 Peldaños y Encimeras disponibles. Pag. 124.

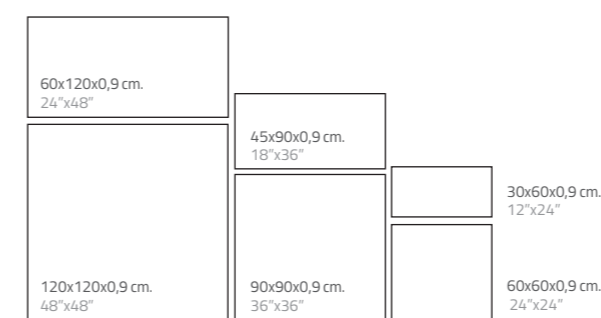

Available Colours:



Wega Dark Grey

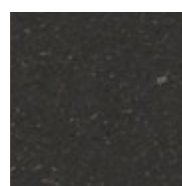

Wega Black

Tech. Porcelain Tiles Available Sizes & Finishes / Formatos y Acabados Disponibles en Porcelánico Tec.

Nominal Size Formato Nominal	Real Size Formato Real	Natural Natural R10 - CB	Price Code Código Precio	Pz/Box	M2/Box	Kg/Box	Box/Pa	M2/Pa	Kg/Pa
30x60 cm. 12"x24"	29,8x59,8x0,9 cm.	●	30T	6	1,07	22,00	48	51,36	1094
60x60 cm. 24"x24"	59,8x59,8x0,9 cm.	●	60T	3	1,07	23,12	40	42,91	949
45x90 cm. 18"x36"	44,8x89,8x0,9 cm.	●	45T	3	1,21	25,50	30	36,21	832
90x90 cm. 36"x36"	89,8x89,8x0,9 cm.	●	90T	2	1,61	34,00	24	38,71	846
60x120 cm. 24"x48"	59,8x119,8x0,9 cm.	●	62T	2	1,43	30,32	24	34,32	728
120x120 cm. 48"x48"	119,8x119,8x0,9 cm.	●	120T	1	1,44	30,50	40	57,41	1265



**Allure Wall**  
Marbled Stone in Ceramics  
Piedra Veteadada Cerámica



Line Relief  
Graphic Scale 1/4

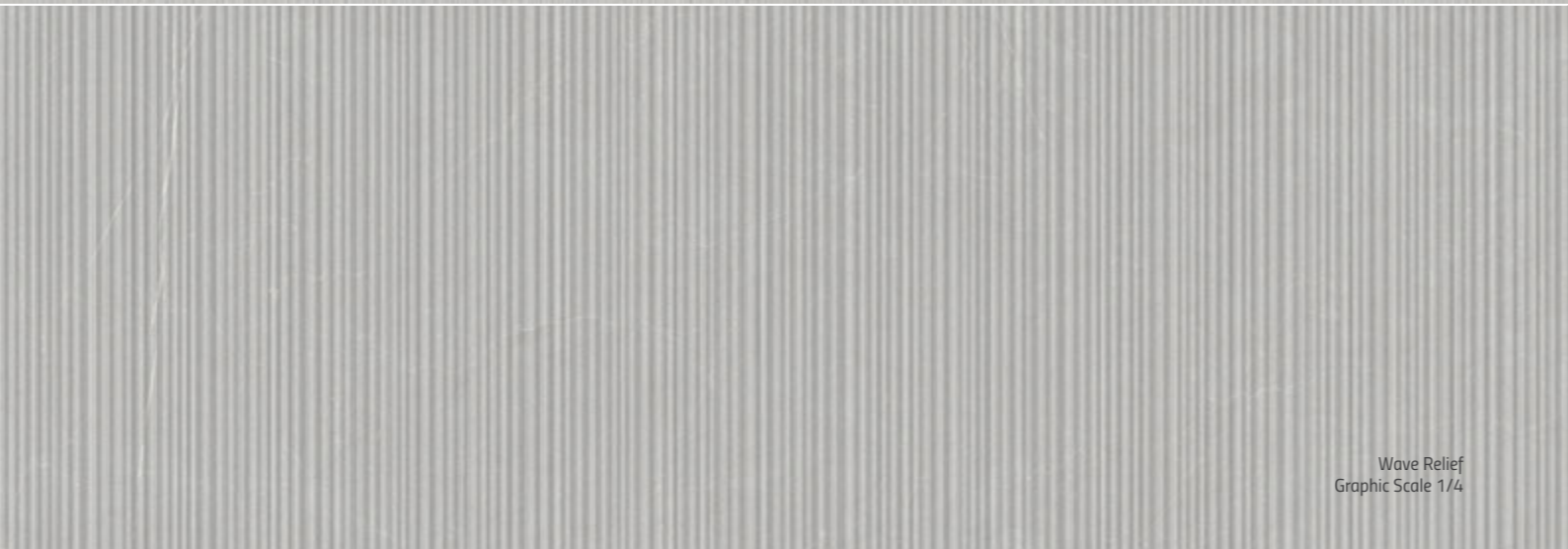

Wave Relief  
Graphic Scale 1/4



Wiggle Relief  
Graphic Scale 1/4

White Body / Pasta Blanca  
Rectified / Destonified V.2 / Rectificado / Destonificado V.2  
N° Designs By Format / N° De Diseños Por Formato : 30X90: 16

Available Colours / Colores Disponibles



Allure Wall White    Allure Wall Light Grey    Allure Wall Anthracite

Available Sizes / Formatos Disponibles

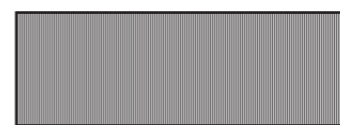

**LINE**  
30x90x0,9 cm.  
12"x36"

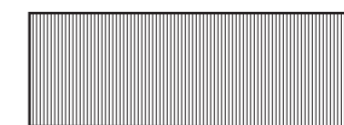

**WAVE**  
30x90x0,9 cm.  
12"x36"

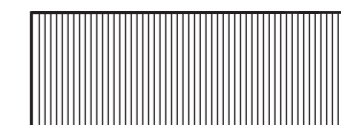

**WIGGLE**  
30x90x0,9 cm.  
12"x36"

Wall Tiles Available Sizes & Finishes / Formatos y Acabados Disponibles en Revestimientos Cerámicos

Nominal Size Formato Nominal	Real Size Formato Real	Line	Wave	Wiggle	Price Code Código Precio	Pz/Box	M2/Box	Kg/Box	Box/Pa	M2/Pa	Kg/Pa
30x90 cm. 12"x36"	29,8x89,8x0,9 cm.	●	●	●	32	4	1,07	18	48	51,38	875

# Bera&Beren Wall

Lusitan & Catalan Limestone Ceramics  
Caliza Lusitana & Catalana Cerámica

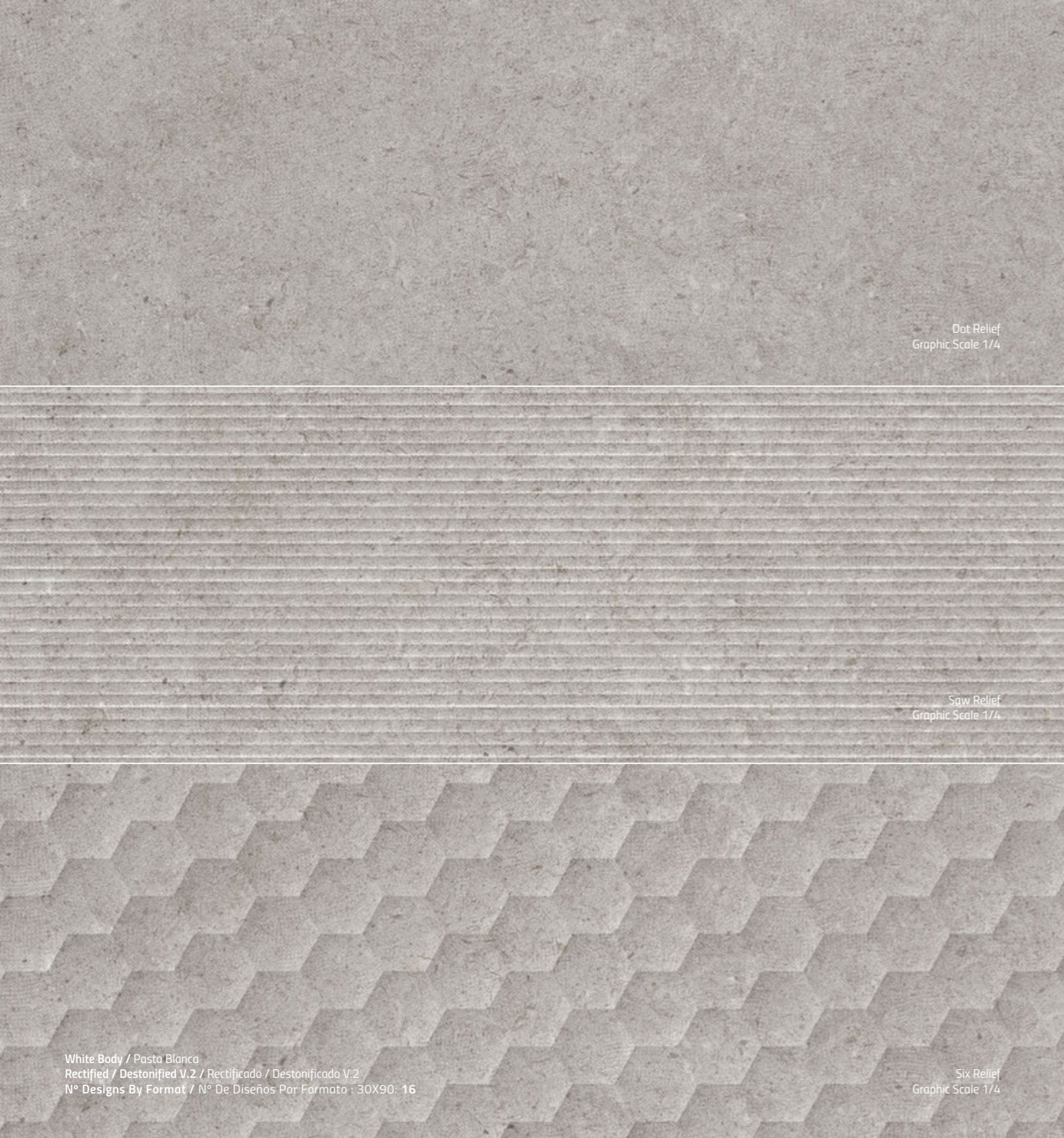

Dot Relief  
Graphic Scale 1/4

Saw Relief  
Graphic Scale 1/4

Six Relief  
Graphic Scale 1/4

White Body / Pasta Blanca  
Rectified / Destonified V.2 / Rectificado / Destonificado V.2  
N° Designs By Format / N° De Diseños Por Formato : 30X90: 16

## Available Colours / Colores Disponibles



Bera Wall White    Beren Wall Light Grey    Beren Wall Biscuit    Beren Wall Dark Grey

## Available Sizes / Formatos Disponibles

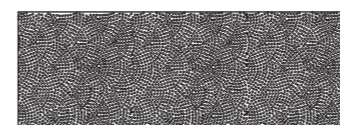

**DOT**  
30x90x0,9 cm.  
12"x36"

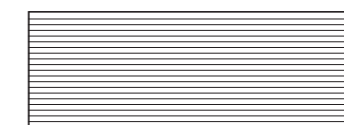

**SAW**  
30x90x0,9 cm.  
12"x36"

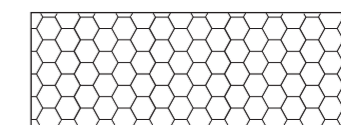

**SIX**  
30x90x0,9 cm.  
12"x36"

## Wall Tiles Available Sizes & Finishes / Formatos y Acabados Disponibles en Revestimientos Cerámicos

Nominal Size Formato Nominal	Real Size Formato Real	Dot	Saw	Six	Price Code Código Precio	Pz/Box	M2/Box	Kg/Box	Box/Pa	M2/Pa	Kg/Pa
30x90 cm. 12"x36"	29,8x89,8x0,9 cm.	●	●	●	32	4	1,07	18	48	51,38	875

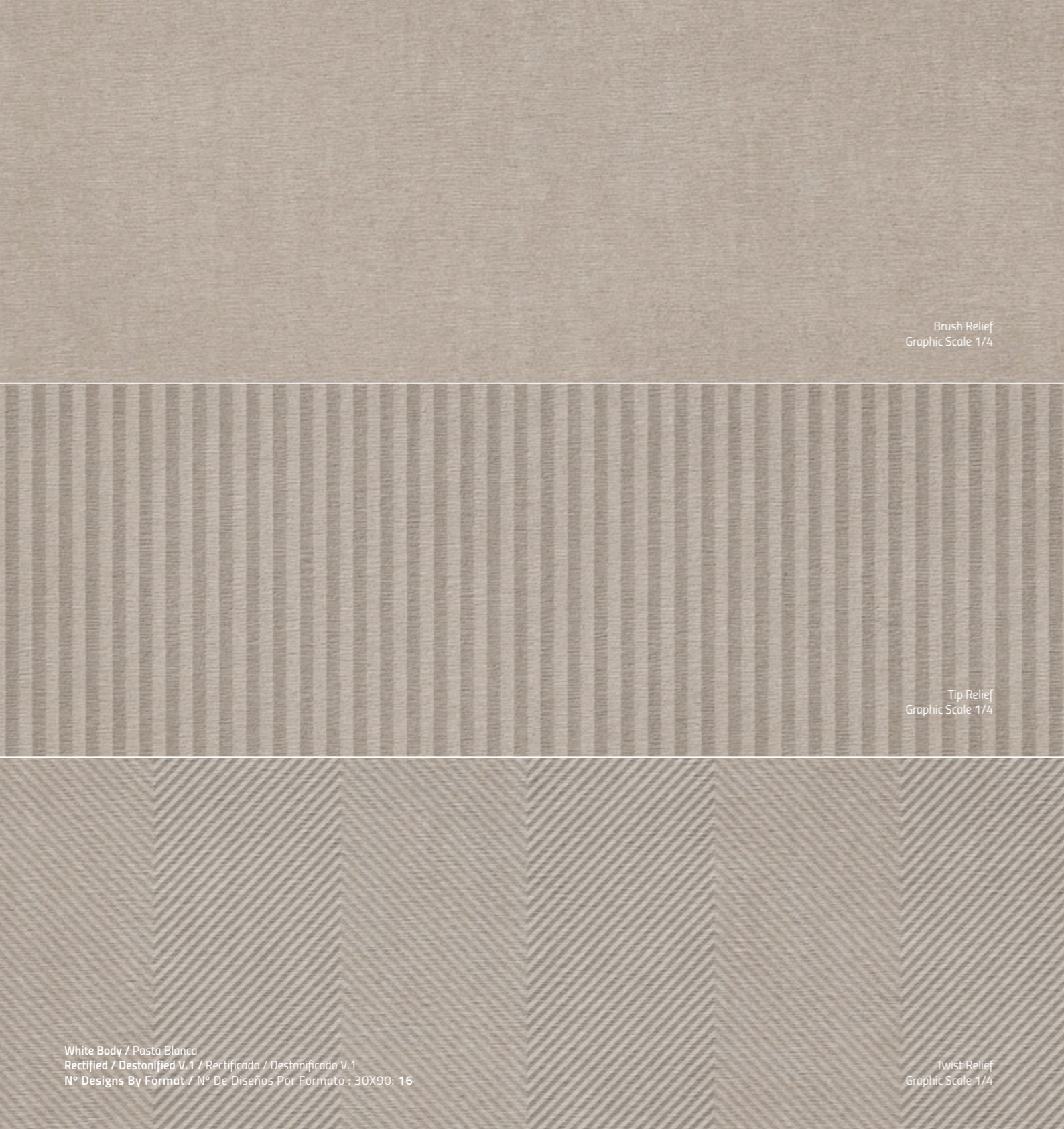

Brush Relief  
Graphic Scale 1/4

Tip Relief  
Graphic Scale 1/4

Twist Relief  
Graphic Scale 1/4

White Body / Pasta Blanca  
Rectified / Destonified V.1 / Rectificado / Destonificado V.1  
N° Designs By Format / N° De Diseños Por Formato : 30X90: 16

Available Colours / Colores Disponibles



Ground Wall Light    Ground Wall Cream    Ground Wall Grey

Available Sizes / Formatos Disponibles

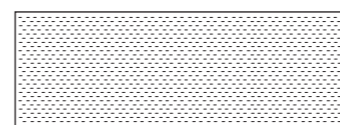

**BRUSH**  
30x90x0,9 cm.  
12"x36"

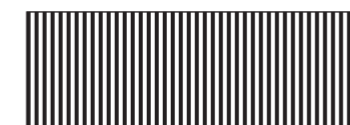

**TIP**  
30x90x0,9 cm.  
12"x36"



**TWIST**  
30x90x0,9 cm.  
12"x36"

Wall Tiles Available Sizes & Finishes / Formatos y Acabados Disponibles en Revestimientos Cerámicos

Nominal Size Formato Nominal	Real Size Formato Real	Brush	Tip	Twist	Price Code Código Precio	Pz/Box	M2/Box	Kg/Box	Box/Pa	M2/Pa	Kg/Pa
30x90 cm. 12"x36"	29,8x89,8x0,9 cm.	●	●	●	32	4	1,07	18	48	51,38	875



Calm Relief  
Graphic Scale 1/4

Prints Relief  
Graphic Scale 1/4

Peak Relief  
Graphic Scale 1/4

White Body / Pasta Blanca  
Rectified / Destonified V.2 / Rectificado / Destonificado V.2  
N° Designs By Format / N° De Diseños Por Formato : 30X90: 16

Available Sizes / Formatos Disponibles

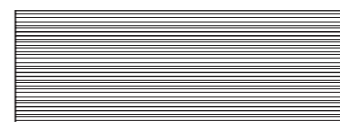

**CALM**  
30x90x0,9 cm.  
12"x36"



**PRINTS**  
30x90x0,9 cm.  
12"x36"

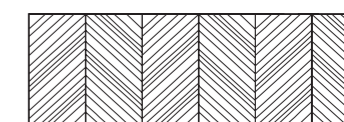

**PEAK**  
30x90x0,9 cm.  
12"x36"

Available Colours / Colores Disponibles

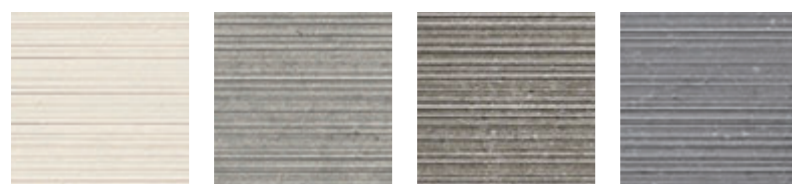

Gubi Wall Light

Gubi Wall Cloud

Gubi Wall Taupe

Gubi Wall Anthracite

Wall Tiles Available Sizes & Finishes / Formatos y Acabados Disponibles en Revestimientos Cerámicos

Nominal Size Formato Nominal	Real Size Formato Real	Calm	Print	Peak	Price Code Código Precio	Pz/Box	M2/Box	Kg/Box	Box/Pa	M2/Pa	Kg/Pa
30x90 cm. 12"x36"	29,8x89,8x0,9 cm.	●	●	●	32	4	1,07	18	48	51,38	875



White Body / Pasta Blanca  
Non Rectified / Destonified V.2 / No Rectificado / Destonificado V.2  
N° Designs By Format / N° De Diseños Por Formato : 7,5x30: 2 / 7,5x15: 4

Glossy Finish  
Graphic Scale 1/2,7

Available Sizes / Formatos Disponibles



7,5x30 cm.  
3"x12"



7,5x15 cm.  
3"x6"

Placement Proposals / Propuestas de Colocación

7,5x15 cm.  
3"x6"

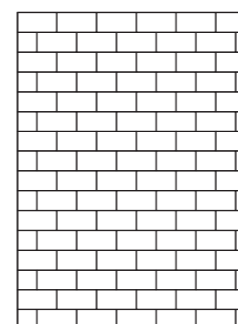

7,5x15 cm.  
3"x6"

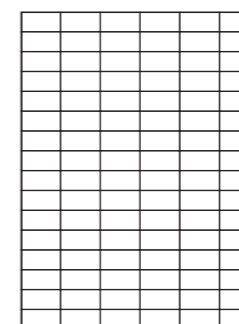

7,5x30 cm.  
3"x12"

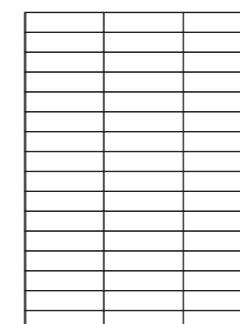

7,5x30 cm.  
3"x12"

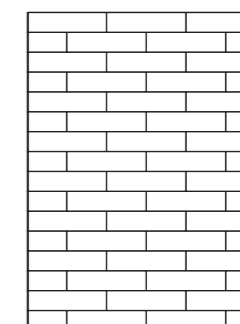

Available Colours / Colores Disponibles

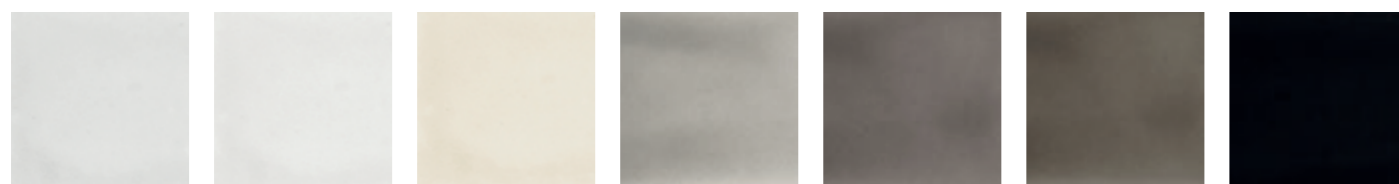

Mayolica White    Mayolica Matt White    Mayolica Ivory    Mayolica Soft Grey    Mayolica Grey    Mayolica Taupe    Mayolica Black

Wall Tiles Available Sizes & Finishes / Formatos y Acabados Disponibles en Revestimientos Cerámicos

Nominal Size Formato Nominal	Real Size Formato Real	Price Code Código Precio	Pz/Box	M2/Box	Kg/Box	Box/Pa	M2/Pa	Kg/Pa
P.B. 7,5x15 cm. 3"x6"	7,5x15 cm.	7	44	0,50	7,04	120	60,00	880
P.B. 7,5x30 cm. 3"x12"	7,5x30 cm.	7	22	0,50	6,60	120	60,00	828

# SIGNATURE SURFACES

The passion we feel at *Living* for good design has resulted in Signature Surfaces. This line comes from the union, from the fusion between the creative talent of great designers and their way of interpreting ceramics, joint with our desire of contributing in the world of interior design and architecture giving unique cutting edge ceramic solutions.

The ending of this collaboration is untold pieces with innovative finishes and textures that grant an exclusive identity to the creation. The personality of the result makes the difference, from the elegance, beauty and sobriety that define us.

La pasión que sentimos en *Living* por el buen diseño ha dado lugar a Signature Surfaces. Esta línea nace de la unión, de la fusión entre el talento creativo de grandes diseñadores y su modo de interpretar la cerámica, junto con nuestro deseo de contribuir en el mundo del interiorismo y la arquitectura aportando soluciones cerámicas únicas de estilo vanguardista. El desenlace de esta colaboración son piezas inéditas con acabados y texturas innovadoras que conceden a la creación una identidad exclusiva. La personalidad del resultado marca la diferencia, desde la elegancia, belleza y sobriedad que nos define.

**Living**ceramics



## Bisel

by Víctor Carrasco

Bisel is the new collection designed by Víctor Carrasco for the Signature Surfaces series at Livingceramics. A collection which transmits the designer's way of conceiving interior design and architecture, drawing from the essential to create pleasant, elegant and inspiring spaces. With ideas designed by and for people.

The base is formed from an imaginary grid upon which the pieces are combined. They have two different surfaces: one smooth and one with a bevel along one of the piece's sides which creates a slightly oversized mosaic effect in the set. The combination of both pieces makes lines of different intensities on the surface, providing many composition possibilities. A collection open to ideas, creativity and diversity. And which reminds us that designing is investigating, experimenting and feeling. Enjoy the experience.

Bisel es la nueva colección que Víctor Carrasco ha diseñado para las series Signature Surfaces de Livingceramics. Una colección que transmite la manera de concebir el interiorismo y la arquitectura del diseñador, partiendo siempre de lo esencial para crear espacios amables, elegantes e inspiradores. Con ideas pensadas desde y para las personas.

La base se forma a partir de una cuadrícula imaginaria sobre la que combinar las piezas, que cuentan con dos superficies distintas: una lisa y una con un bisel a lo largo de uno de los laterales de la pieza que crea un efecto de mosaico ligeramente sobredimensionado en el conjunto. La combinación de ambas piezas forma líneas de diferentes intensidades en la superficie, aportando muchas posibilidades de composición. Una colección abierta a las ideas, a la creatividad y la diversidad. Y a que recordemos que diseñar es investigar, experimentar y sentir. Disfruta de la experiencia.

Víctor Carrasco

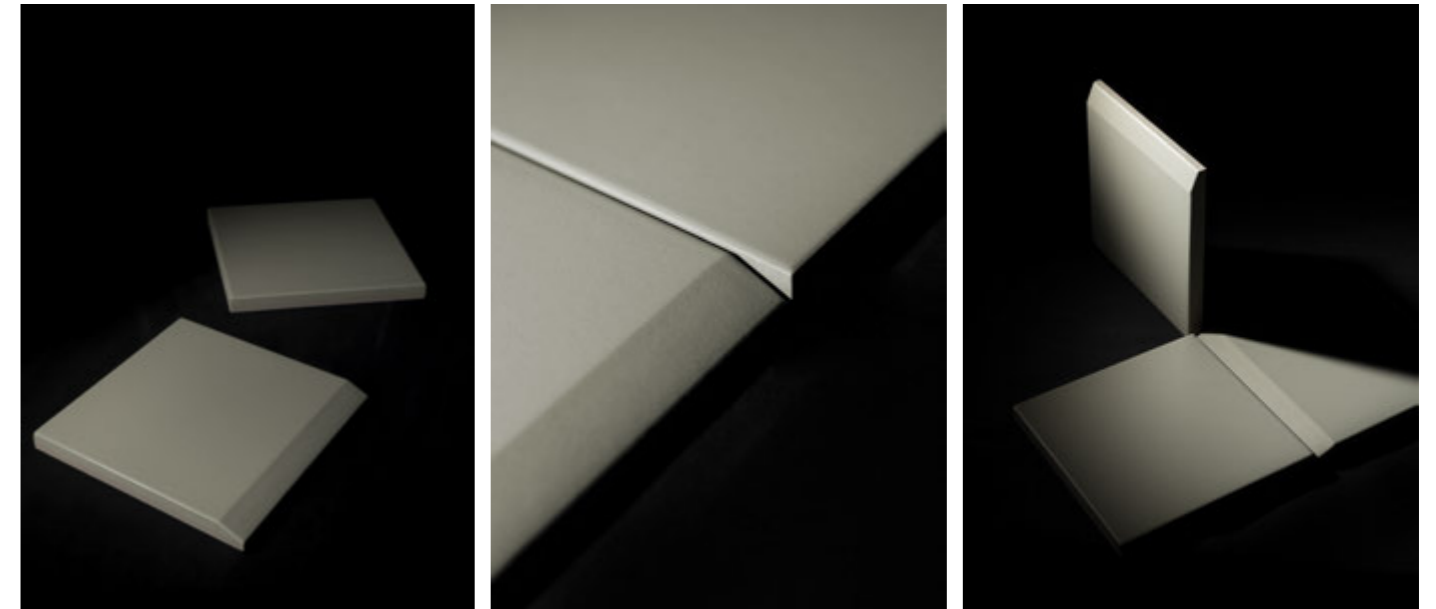

Two different pieces for infinite combinations



Bisel Linen 15x15 cm. (6"x6")



Bisel Pietra 15x15 cm. (6"x6")



Thus Bisel, a collection which showcases the idea as a fundamental part of the design, came into existence. The power of a pencil and a blank sheet of paper, the process of thinking and exploring as the origin of everything which is to come. That enthusiasm and enjoyment one feels when starting a project, which should never be forgotten.

In Bisel, everything is still unwritten. As a starting point: a format, two surfaces and seven colours which will help you think beyond, giving shape to ideas and creating innovative compositions. An apparently simple proposal originating from a deep reflection on our behaviour and interaction with the space. A differentiation tool so that from my side I leave 50% of the design on the table, with the user completing the other 50% with their choice.

Así nace Bisel, una colección que ensalza a la idea como parte fundamental del diseño. El poder de la hoja en blanco y el lápiz, el proceso de pensar y explorar como origen de todo lo que vendrá después. Ese entusiasmo y disfrute que se siente al iniciar un proyecto y que no debería olvidarse jamás.

En Bisel aún no hay nada escrito. Como punto de partida, un formato, dos superficies y siete colores que te ayudarán a pensar más allá, dar forma a las ideas y crear composiciones novedosas. Una aparente simple propuesta nacida de una profunda reflexión sobre nuestro comportamiento e interacción con el espacio. Una herramienta de diferenciación en la que Víctor Carrasco deja sobre la mesa el 50% del diseño siendo el usuario quien complete el otro 50% a su elección.

Technical Specifications / Especificaciones Técnicas

White Body / Pasta Blanca  
 Non Rectified / Destonified V.0 / No Rectificado / Destonificado V.0  
 N° Designs By Format / N° De Diseños Por Formato:  
 15x15: 1



Design Collection / Diseño de la Colección

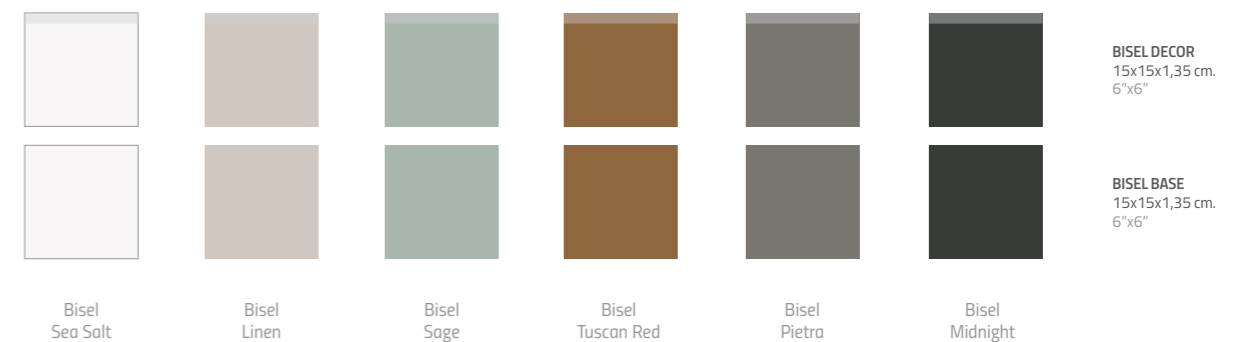

Wall Tiles Available Sizes & Finishes / Formatos y Acabados Disponibles en Revestimiento

Nominal Size Formato Nominal	Real Size Formato Real	Natural Natural	Price Code Código Precio	Pz/Box	M2/Box	Kg/Box	Box/Pa	M2/Pa	Kg/Pa
BISEL DECOR 15x15 cm. 6"x6"	15x15x1,35 cm.	●	51	16	0,36	7,85	120	43,2	942
BISEL BASE 15x15 cm. 6"x6"	15x15x1,35 cm.	●	51	16	0,36	7,85	120	43,2	942

# Balance

by Víctor Carrasco

The incidence of light is represented in the different formats, creating a certain relationship between the combination of the different pieces and finishes. Luminosity and opacity are reflected in this collection, these are brought together and supplement one another through their contrasting yet connecting tonalities.

In the Balance collection all of the superfluous and redundant elements have been eliminated and the pieces which make up this collection are defined by their exquisite design, which represents both the heart and soul of the light; an element which despite being so simple, brings great value to the space it complements. Through its well-thought out study of gradients, this collection looks to reflect the real power of this piece, using intensity to turn it into a truly unique element.

La colección Balance es un sutil ejercicio de iluminación sobre cuidados materiales creando un collage de sinuosas luces y sombras. Atemporal y sorpresiva, Balance nace para crear espacios nobles. La elegancia se aprecia entre las luces y sombras con una gran sutileza; reflejando su paso a través de la pieza, se consigue un acabado sutil y natural.

La incidencia de la luz se representa en los diferentes formatos, creando una relación y complementación entre la combinación de las diferentes piezas y acabados. Se refleja la luminosidad y la opacidad, uniéndose y complementándose mediante tonalidades que contrastan y se relacionan a su vez.

Balance elimina elementos superfluos y redundantes, definiendo unas piezas con un diseño exquisito que representan la esencia y el alma de la luz. Un elemento tan simple, pero que a su vez añade un gran valor, al espacio que complementa. Su poder se ha querido reflejar mediante una estudiada representación de degradados, transmitiendo el juego de su intensidad que convierte una pieza en un elemento único.

Víctor Carrasco

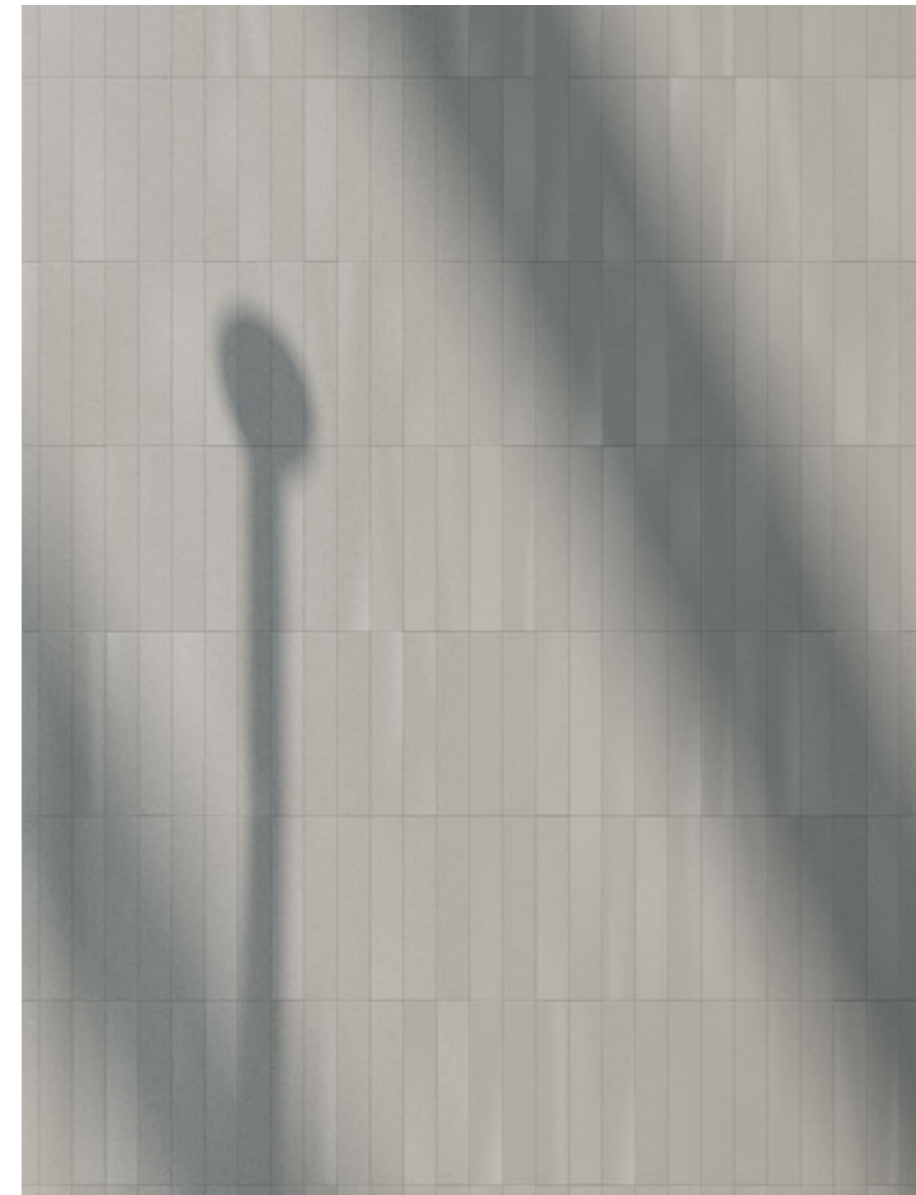

Balance Pavilion Grey 5x30 cm. (2"x12")



Balance by Víctor Carrasco

115

In architectural design, importance has always been placed on letting light reach where it is needed most. Light becomes the protagonist of the piece, enabling shadows to emerge, reflecting a mixture of light and dark tonalities and textures. A certain poetry is reflected and defined through these contrasts, highlighting every individual detail in this dance of shadows.

Desde los inicios de la arquitectura la conducción de la luz hacia donde más se necesitaba ha sido una prioridad ante cada nuevo proyecto. La luz se convierte en la protagonista, representando su papel principal, nacen sombras que reflejan un juego entre tonalidades, claroscuros y texturas. La poesía se refleja y define mediante contrastes, realzando cada detalle y estableciendo un baile de sombras.

Technical Specifications / Especificaciones Técnicas

Color Body Porcelain / Porcelánico Masa Coloreada  
 Rectified / Destonified V.4 / Rectificado / Destonificado V.4  
 Nº Designs By Format / Nº De Diseños Por Formato :  
 5x15: 56 / 5x30: 28 / 10x10: 55

Design Collection / Diseño de la Colección

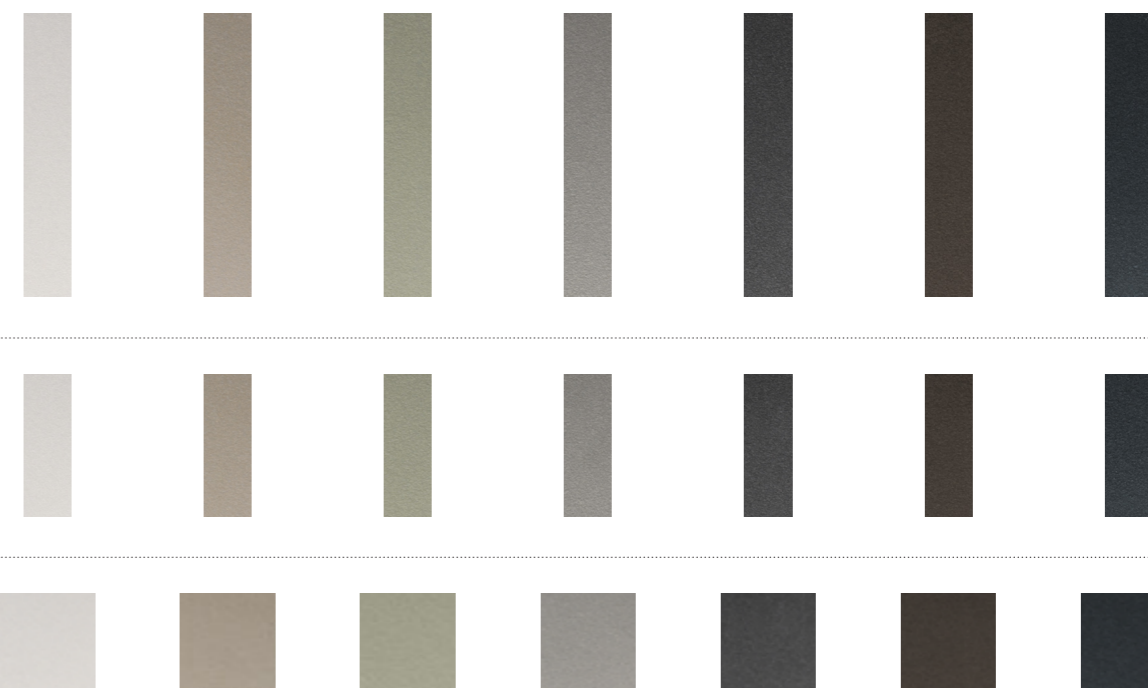

Balance Moon White    Balance Clay    Balance Olive    Balance Pavilion Grey    Balance Basalt    Balance Silt    Balance Ocean

Balance Basalt 5x15 cm. (2"x6")

Porcelain Tiles Available Sizes & Finishes / Formatos y Acabados Disponibles en Porcelánico

Nominal Size Formato Nominal	Real Size Formato Real	Natural Natural C1 · R9 · CA	Price Code Código Precio	Pz/Box	M2/Box	Kg/Box	Box/Pa	M2/Pa	Kg/Pa
5x15 cm. 2"x6"	4,8x14,8x0,9 cm.	●	50-1	60	0,43	9,60	60	25,80	612
5x30 cm. 2"x12"	4,8x29,8x0,9 cm.	●	50-2	30	0,43	9,60	60	25,80	612
10x10 cm. 4"x4"	9,8x9,8x0,9 cm.	●	50-3	45	0,43	9,60	60	25,80	612

# Cava

by LucidiPevere

Cava is the new collection designed by the Italian studio LucidiPevere, it arises from a mix of formats, decorations engraved on the piece and a play with the color scheme. Combining recorded and flat surfaces endless compositions are born. It is not until the installation of the chosen color joint is completed, that the collection takes sense: real leaks and mixed engravings are confused resulting in the final decoration >. LP

Cava es la nueva colección diseñada por el estudio italiano LucidiPevere, surge de una mezcla de formatos, decoraciones grabadas sobre la pieza y un juego con las combinaciones de colores. De la combinación de superficies grabadas y lisas nacen infinitas posibilidades de composición. No es hasta que se completa la instalación con la junta de color escogida, cuando la colección cobra el sentido completo: fugas reales y grabados que se mezclan y confunden dando lugar a la decoración final >. LP

LucidiPevere



Luca Pevere & Paolo Lucidi



Cava Brown 15.B + J · Turquoise



Cava Mosaic Beige. E + J. Tierra de Siena

Technical Information / Información Técnica

Color Body Porcelain / Porcelánico Masa Coloreada  
 Rectified / Destonified V.2 / Rectificado / Destonificado V.2  
 N° Designs By Format / N° De Diseños Por Formato :  
 90x90: 3 / 45x90: 6 / 60x60: 3 / 30x60: 6 / 10x60: 18 / 15x30: 24 / 7,5x30: 48 / 13x15: 48



Available Colours / Colores Disponibles

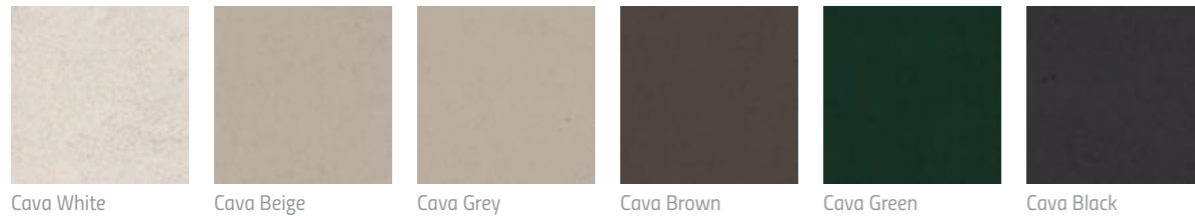

Cava Graphic Patterns / Patrones Gráficos Cava

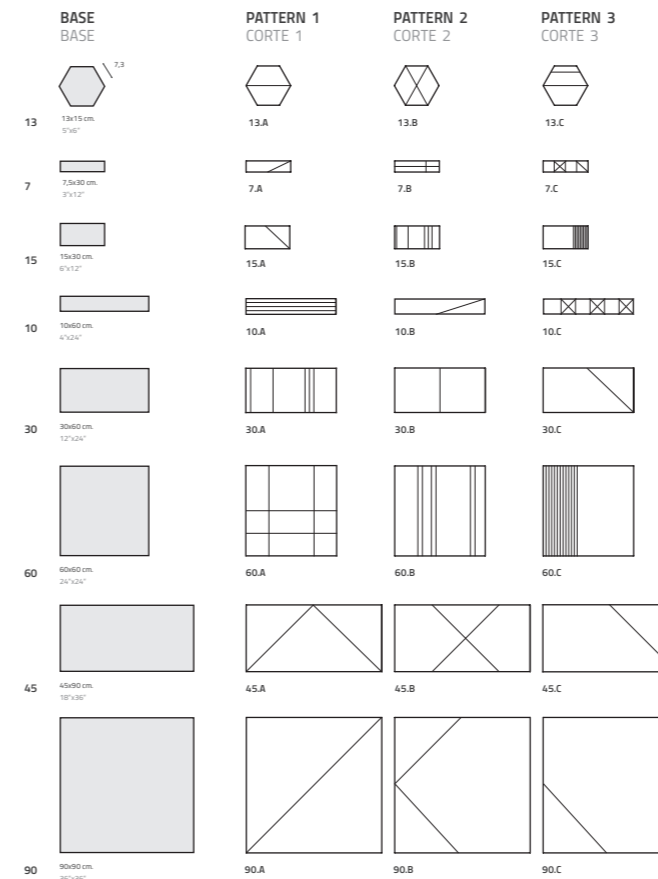

Cava Mosaic Graphic Patterns / Patrones Gráficos Cava Mosaic

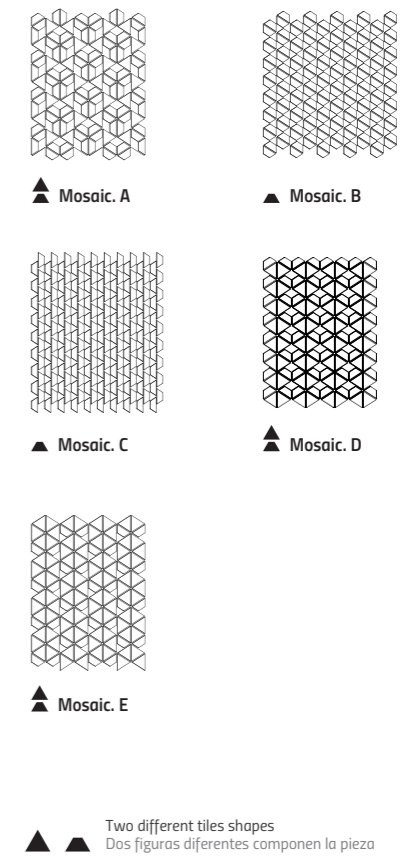

Porcelain Tiles Available Sizes & Finishes / Formatos y Acabados Disponibles en Porcelánico

Nominal Size Formato Nominal	Real Size Formato Real	Natural Natural C1 · R9 · CA	Price Code Código Precio	Pz/Box	M2/Box	Kg/Box	Box/Pa	M2/Pa	Kg/Pa
13x15 cm. 5"x6"	12,6x14,6x0,9 cm.	●	11	24	0,33	8,40	60	19,96	540
7,5x30 cm. 3"x12"	7,3x29,8x0,9 cm.	●	12	24	0,52	11,52	60	31,33	703
15x30 cm. 6"x12"	14,8x29,8x0,9 cm.	●	13	12	0,53	11,76	60	31,75	742
10x60 cm. 4"x24"	9,8x59,8x0,9 cm.	●	14	10	0,59	13,30	60	35,40	837
30x60 cm. 12"x24"	29,8x59,8x0,9 cm.	●	30	6	1,07	22,74	40	42,80	940
60x60 cm. 24"x24"	59,8x59,8x0,9 cm.	●	60	3	1,07	23,22	40	42,91	962
45x90 cm. 18"x36"	44,8x89,8x0,9 cm.	●	45	3	1,21	25,50	32	38,62	849
90x90 cm. 36"x36"	89,8x89,8x0,9 cm.	●	90	2	1,62	40,00	27	43,74	1100
Cava Mosaic. A.	22,8x27,8x0,9 cm.	●	20-1	5	0,31	9,00	60	19,02	565
Cava Mosaic. B.	27,5x29,6x0,9 cm.	●	20-2	5	0,40	9,00	60	24,42	565
Cava Mosaic. C.	29,5x29,9x0,9 cm.	●	20-3	5	0,44	9,00	60	26,46	565
Cava Mosaic. D.	22,8x27,1x0,9 cm.	●	20-4	5	0,30	9,00	60	18,54	565
Cava Mosaic. E.	22,8x27,8x0,9 cm.	●	20-5	5	0,31	9,00	60	19,02	565

# 20MM Thickness Floor

## 20mm. Porcelain Tiles

Porcelánico en 20mm.

Extra-thick porcelain tiles offer numerous benefits, thanks to their versatility and high resistance. These are properties fully able to meet the tough technical demands and aesthetic requirements of outdoor spaces, public areas, and places subject to high loads or stresses.

The tiles can be used in false floor systems, creating raised access flooring that provides easy access to plumbing and electricity networks. They are swift and easy to lay, and the perfect choice for outdoor areas.

El gres porcelánico espesorado ofrece múltiples ventajas gracias a su elevada resistencia y versatilidad. Características que responden a las más altas exigencias a nivel técnico y estético que requieren zonas de exterior, áreas públicas y zonas sometidas a altas cargas y tensiones.

Permite su ejecución en sistemas registrables, ofreciendo suelos técnicos elevados fácilmente accesibles a instalaciones de fontanería y electricidad. Rápido y fácil en su ejecución, se trata de un material perfecto para el pavimentado de exteriores.

### Allure

Marbled Stone in Ceramics  
Piedra Veteada Cerámica



### Bera&Beren

Lusitan & Catalan Limestone Ceramics  
Caliza Lusitana & Catalana Cerámica

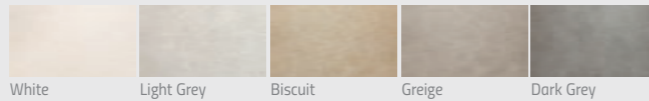

### Eme

Mediterranean Stone in Ceramics  
Piedra mediterránea Cerámica

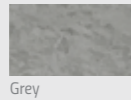

### Gubi

Microcement Ceramics  
Microcemento Cerámico

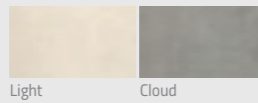

### Kendo

Jura Stone in Ceramics  
Piedra Jura en Cerámica

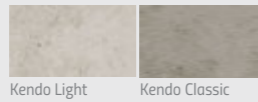

### Kovo

Mixed Concrete in Ceramics  
Mezcla de Cementos en Cerámica

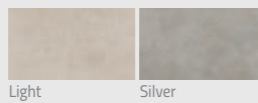

### Noon

Northern Stone in Ceramics  
Piedra del Norte Cerámica

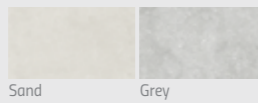

### Verso Vein Cut

Travertine Stone in Ceramics  
Piedra Travertino en Cerámica

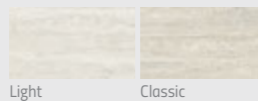

### Verso Cross Cut

Travertine Stone in Ceramics  
Piedra Travertino en Cerámica

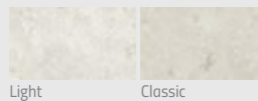

### Vonn

Textured Stone in Ceramics  
Piedra Texturada en Cerámica

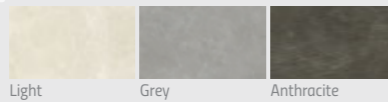

Our 20mm-thick collections have the same design as the 9mm-thick tile series by Livingceramics. This means that matching tiles can be used both indoors and out, ensuring seamless visual continuity. This is a definite asset in the design of spaces for residential, leisure or public use.

Nuestras colecciones de 20mm mantienen el diseño de las Series de 9mm de Livingceramics. Por tanto, ofrecen la posibilidad de emplear el mismo material tanto en la zona interior como en la exterior, haciendo desaparecer los límites entre áreas y ofreciendo así continuidad visual al espacio. Una cualidad muy valorada a la hora de diseñar espacios como residenciales, zonas de ocio o espacios públicos.



Thanks to the high resistance and inalterability of our 20mm-thick porcelain tiles, they are ideal for places subject to adverse conditions and extreme temperatures, such as covered terraces, gardens or patios.

Las cualidades técnicas de resistencia e inalterabilidad que presenta el gres porcelánico de 20mm lo hacen idóneo para revestir las áreas más expuestas a condiciones adversas: zonas de exterior como porches, jardines o terrazas en las que las temperaturas extremas inciden de manera directa.

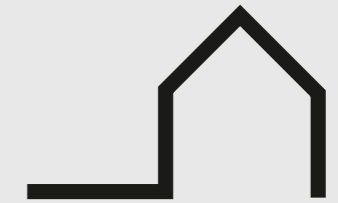

All our 20mm-thick tile series are non-slip, guaranteeing a safe grip in wet areas or places close to water, such as poolside terraces. Likewise, the tiles are non-porous; that is, they do not absorb water and so they will not crack. What is more, they do not require any kind of special treatment.

Todas nuestras series disponibles en 20mm cuentan con acabado anti slip, destinado a garantizar la seguridad en zonas húmedas o cercanas al agua, como los bordes de las piscinas. Asimismo, al tratarse de un material no poroso, no absorbe agua y, por tanto, no se agrieta y no requiere de tratamientos específicos.

In order to ensure visual continuity between indoor and outdoor areas and to fit in with the needs of each individual project, extra-thick special porcelain tile pieces are available, such as step tiles, skirting tiles, corner tiles and finishing pieces. The range's high versatility contributes to projects' visual coherence.

Con el fin de mantener la continuidad estética entre los espacios interiores y exteriores y adaptarse a cada proyecto, el gres porcelánico espesorado se utiliza en piezas especiales como peldaños, zócalos, ángulos y remates cerámicos. La elevada versatilidad del material facilita la coherencia visual en el resultado final del proyecto.



**Dimensions**  
Dimensiones

Our thickened porcelain is available in the 90x90cm and 120x120cm formats.  
Nuestro porcelánico espesorado está disponible en los formatos de 90x90cm y 120x120cm.

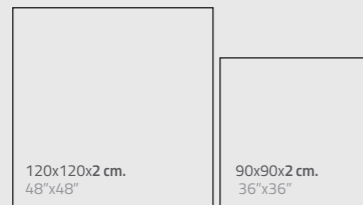

- |   |   |  |
|---|---|--|
| Breaking Strength                           |  | Resistencia a la Flexión                         |
| Break Resistance                            |  | Resistencia a la Rotura                          |
| Waterproof Material                         |  | Material Impermeable                             |
| UV Resistant                                |  | Resistencia a los Rayos UV                       |
| Frost Resistant                             |  | Resistencia a la Climas Extremos                 |
| Resistant to Chemical Agents and Detergents |  | Resistencia a los Agentes Químicos y Detergentes |
| Easy to Clean                               |  | Fácil Limpieza                                   |
| Reusable and Accesible                      |  | Registrable y Reutilizable                       |
| Fast Installation                           |  | Rápida Colocación                                |
| Easy to Install                             |  | Fácil Instalación                                |
| Colour Stability                            |  | Estabilidad Cromática                            |



## 9&20MM THICKNESS

### STANDARD STEP TILES

#### Standard Step Tiles Specifications Especificaciones De Peldaños Estándar

COLOR BODY PORCELAIN / PORCELÁNICO MASA COLOREADA  
RECTIFIED / REINFORCEMENT SIDES / RECTIFICADO / REFUERZO DE CANTOS

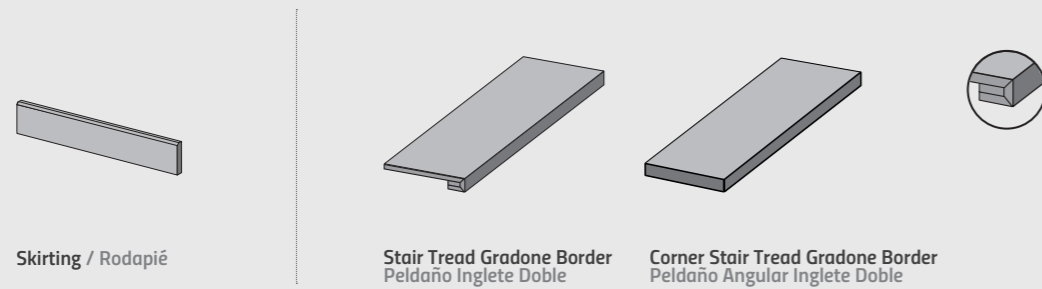

Skirting / Rodapié

Stair Tread Gradone Border  
Peldaño Inglete Doble

Corner Stair Tread Gradone Border  
Peldaño Angular Inglete Doble

#### Other Special Pieces Otras Piezas Especiales

Our solutions include customized steps from our mass colored porcelain lines. It is a product capable of adjusting to any type of stairs: catalan stair, floating stairs, turning floating stairs. The measurements and data are recorded in a simple form, collecting the necessary information for cutting the steps.

Nuestras soluciones incluyen peldaños a medida de nuestras colecciones de porcelánico de masa coloreada. Un producto a medida capaz de adecuarse a cualquier tipo de escalera: escalera catalana, escalera colgada, de ojo colgada... Los datos y medidas se anotan en un sencillo formulario que recoge toda la información necesaria para el corte de los peldaños.

#### Tailored Step Tiles Specifications. OTHER FINISHES Especificaciones De Peldaños A Medida. OTROS ACABADOS

COLOR BODY PORCELAIN / PORCELÁNICO MASA COLOREADA  
RECTIFIED / REINFORCEMENT SIDES / RECTIFICADO / REFUERZO DE CANTOS

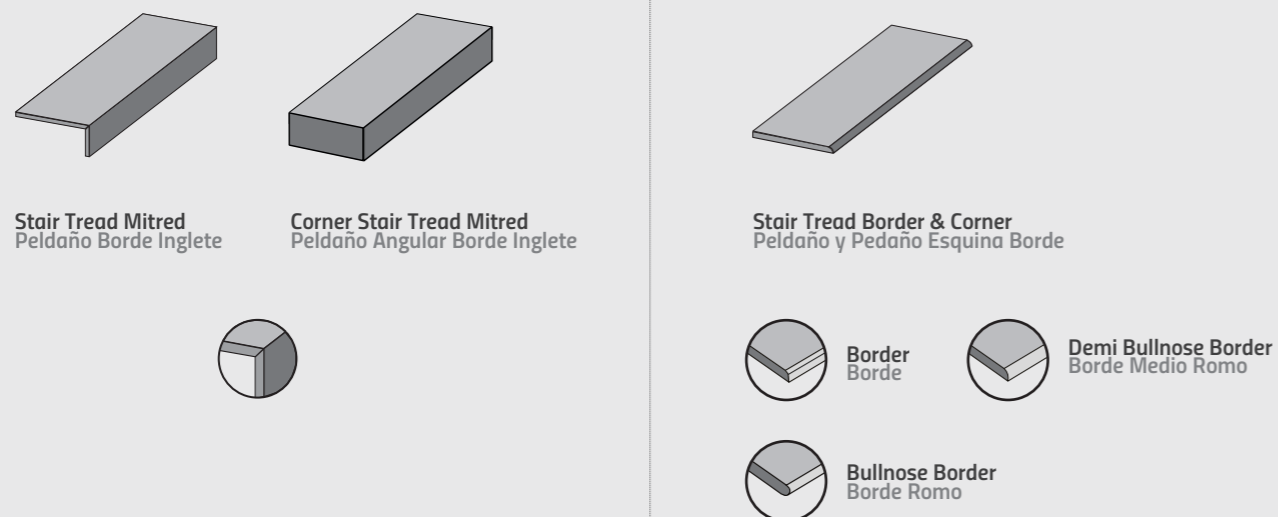

Stair Tread Mitred  
Peldaño Borde Inglete

Corner Stair Tread Mitred  
Peldaño Angular Borde Inglete

Stair Tread Border & Corner  
Peldaño y Pedaño Esquina Borde



Bullnose Border  
Borde Romo



Demi Bullnose Border  
Borde Medio Romo

## POOL SPECIAL PIECES

20MM Pool Grid Example  
Ejemplo Rejillas 20MM



#### Special Pieces / Pool Grids Piezas Especiales / Rejillas de Piscina

Extra-thick porcelain tiles offer numerous benefits, thanks to their versatility and high resistance. These are properties fully able to meet the tough technical demands and aesthetic requirements of outdoor spaces, public areas, and places subject to high loads or stresses. The tiles can be used in false floor systems, creating raised access flooring that provides easy access to plumbing and electricity networks. They are swift and easy to lay, and the perfect choice for outdoor areas.

El gres porcelánico espesorado ofrece múltiples ventajas gracias a su elevada resistencia y versatilidad. Características que responden a las más altas exigencias a nivel técnico y estético que requieren zonas de exterior, áreas públicas y zonas sometidas a altas cargas y tensiones. Permite su ejecución en sistemas registrables, ofreciendo suelos técnicos elevados fácilmente accesibles a instalaciones de fontanería y electricidad. Rápido y fácil en su ejecución, se trata de un material perfecto para el pavimentado de exteriores.

#### 20MM Standard Pieces for Pools Piezas Estándar para Piscinas en 20MM

COLOR BODY PORCELAIN / PORCELÁNICO MASA COLOREADA  
RECTIFIED / REINFORCEMENT SIDES / RECTIFICADO / REFUERZO DE CANTOS

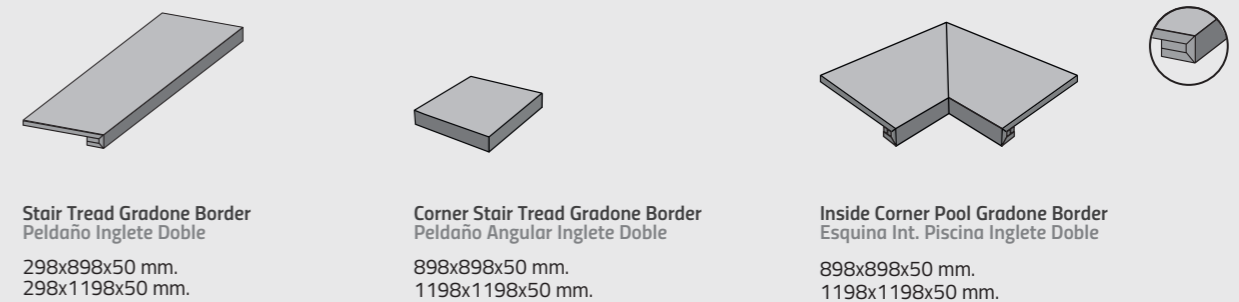

Stair Tread Gradone Border  
Peldaño Inglete Doble  
298x898x50 mm.  
298x1198x50 mm.

Corner Stair Tread Gradone Border  
Peldaño Angular Inglete Doble  
898x898x50 mm.  
1198x1198x50 mm.

Inside Corner Pool Gradone Border  
Esquina Int. Piscina Inglete Doble  
898x898x50 mm.  
1198x1198x50 mm.

#### Tailored Step Tiles Specifications. OTHER POOL FINISHES Especificaciones De Peldaños A Medida. OTROS ACABADOS PARA PISCINAS

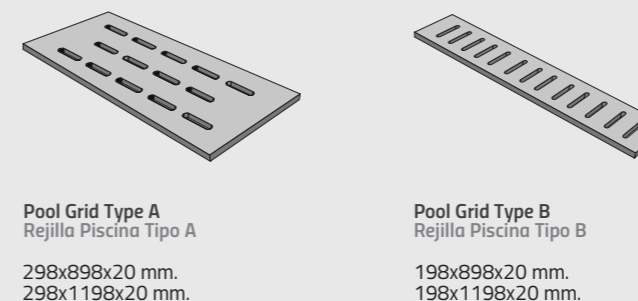

Pool Grid Type A  
Rejilla Piscina Tipo A  
298x898x20 mm.  
298x1198x20 mm.

Pool Grid Type B  
Rejilla Piscina Tipo B  
198x898x20 mm.  
198x1198x20 mm.



Porcelain Tiles Available Sizes & Finishes

Formatos y Acabados Disponibles en Porcelánico

Nominal Size Formato Nominal	Real Size Formato Real	Nat/SBH Finish Acabado Natural Abujardado Suave	Anti-Slip Antideslizante	Price Code Código Precio	Pz/Box	ML/Box	Kg/Box	Box/Pa	M2/Pa	Kg/Pa
Skirting / Rodapié 5x60 cm.	4,8x59,8x0,9 cm.	●		561	5	2,99	3,00	120	-	-
Skirting / Rodapié 5x90 cm.	4,8x89,8x0,9 cm.	●		591	5	4,49	5,50	70	-	-
Skirting / Rodapié 5x120 cm.	4,8x119,8x0,9 cm.	●		521	5	5,99	7,00	70	-	-
Stair Tread Gradone Border 33,3x60 cm. Peldaño Inglete Doble 33,3x60 cm.	33,3x59,8	●	●	360	2	1,20	-	-	-	-
Stair Tread Gradone Border 33,3x90 cm. Peldaño Inglete Doble 33,3x90 cm.	33,3x89,8	●	●	390	2	1,80	-	-	-	-
Stair Tread Gradone Border 33,3x120 cm. Peldaño Inglete Doble 33,3x120 cm.	33,3x119,8	●	●	792	2	2,40	-	-	-	-
Corner Stair Tread Gradone Border 33,3x60 cm. Peldaño Angular Inglete Doble 33,3x60 cm.	33,3x59,8	●	●	361	1	0,60	-	-	-	-
Corner Stair Tread Gradone Border 33,3x90 cm. Peldaño Angular Inglete Doble 33,3x90 cm.	33,3x89,8	●	●	391	1	0,90	-	-	-	-
Corner Stair Tread Gradone Border 33,3x120 cm. Peldaño Angular Inglete Doble 33,3x120 cm.	33,3x119,8	●	●	822	1	1,20	-	-	-	-

20MM Step Tile & Countertops Availables. Check for Packaging.  
Peldaños y Encimeras disponibles en 20MM. Consulte el Embalaje.

Step Tiles Example  
Ejemplo De Peldaños



Order Special Pieces On The Web  
Hoja De Piezas Especiales En La Web



**Livingceramics** ORDER FORM PLAN 11.22 SPECIAL PIECES  
HOJA DE PEDIDO 11.22: PIEZAS ESPECIALES

CÓDIGO: \_\_\_\_\_ CLIENTE: \_\_\_\_\_ FECHA: \_\_\_\_\_  
 MODELO / COLOR: \_\_\_\_\_ FINISH: Select finish / Selec. acabado...  
 INDICATE TONE: \_\_\_\_\_ INDIFFERENT   
 THICKNESS:  6 mm  9 mm  20 mm **4** NUMBER OF UNITS: \_\_\_\_\_  
 TYPE OF PIECE:  STAR TREAD BORDER  STAR TREAD SEMI-BELLINO BORDER  STAR TREAD BELLINO BORDER  
 STAR TREAD GRADONE BORDER  ROUGH CORNER POOL GRADONE BORDER  OUTSIDE CORNER POOL GRADONE BORDER  
 STAR TREAD MIMED  POOL GRID TYPE A  POOL GRID TYPE B  
 INCLUDE CRISP EDGE  INCLUDE EXTRA GRIP  NUMBER OF GROOVES: \_\_\_\_\_  
 DIMENSIONS: A= \_\_\_\_\_ CM B= \_\_\_\_\_ CM Th= \_\_\_\_\_ CM Edges Treatment: FRONT:  RIGHT:  LEFT:  BACK:   
 OBSERVATIONS: \_\_\_\_\_  
 T: +34 964 914 181 / F: +34 964 914 250 WWW.LIVINGCERAMICS.COM - COMERCIAL@LIVINGCERAMICS.COM

BATHROOM FURNITURE SERIES

Special Pieces / Tailored Countertops  
Piezas Especiales / Encimeras A Medida

The versatility of our mass colored porcelain pieces allows us to manufacture countertops for bathrooms increasing the decorative options of our lines. The format is customized according to the needs of each client. The measurements and data are recorded in a simple collecting the necessary information for the production of the countertop.

La versatilidad de nuestras piezas porcelánicas de masa coloreada, permite elaborar encimeras para baños aumentando las opciones decorativas de las colecciones. El formato se personaliza en función de las necesidades de cada cliente. Los datos y medidas se anotan en un sencillo formulario que recoge toda la información necesaria para la producción de la encimera.

Countertop Specifications  
Especificaciones De Encimeras

COLOR BODY PORCELAIN / PORCELÁNICO MASA COLOREADA  
RECTIFIED / REINFORCEMENT FIBERGLASS POLYESTER RESIN  
RECTIFICADO / REFUERZO DE FIBRA DE VIDRIO CON RESINA POLIÉSTER

Basins  
Lavabos



BATHROOM COUNTERTOPS  
ENCIMERAS DE BAÑO

Order Plan Sheet On The Web  
Hoja De Pedido En La Web

**Livingceramics** HOJA DE PEDIDO: ENCIMERAS  
ORDER FORM PLAN: COUNTERTOPS

CÓDIGO: \_\_\_\_\_ CLIENTE: \_\_\_\_\_ FECHA: \_\_\_\_\_  
 MODELO / COLOR: \_\_\_\_\_ ESPESOR: \_\_\_\_\_  
 Nº DE UNIDADES: \_\_\_\_\_  
 DISEÑO DE ENCIMERA: RELENAR LOS SIGUIENTES CAMPOS Y MARCAR LAS CASILLAS CORRESPONDIENTES  
 DIMENSIONES: A= \_\_\_\_\_ CM B= \_\_\_\_\_ CM h= \_\_\_\_\_ CM  
 LATERALES A TRATAR: 1=  2=  3=   
 AGUJEROS DE DESAGUE: C<sub>1</sub>= \_\_\_\_\_ CM C<sub>2</sub>= \_\_\_\_\_ CM D<sub>1</sub>= \_\_\_\_\_ CM D<sub>2</sub>= \_\_\_\_\_ CM  
 AGUJEROS GRIFFERIA: E<sub>1</sub>= \_\_\_\_\_ CM E<sub>2</sub>= \_\_\_\_\_ CM F<sub>1</sub>= \_\_\_\_\_ CM F<sub>2</sub>= \_\_\_\_\_ CM  
 ESTRUCTURA DE APOYO:  SI  NO  
 MATERIAL EN STOCK:  SI  NO  
 OBSERVACIONES: \_\_\_\_\_  
 T: +34 964 914 181 / F: +34 964 914 250 WWW.LIVINGCERAMICS.COM - COMERCIAL@LIVINGCERAMICS.COM

FURNITURE SERIES & BASINS  
MUEBLES DE BAÑO Y LAVABOS

Order Plan Sheet On The Web  
Hoja De Pedido En La Web



**Livingceramics** HOJA DE PEDIDO: BAÑO  
ORDER FORM PLAN: BATHROOM

CÓDIGO: \_\_\_\_\_ CLIENTE: \_\_\_\_\_ FECHA: \_\_\_\_\_  
 RELENAR LOS SIGUIENTES CAMPOS Y MARCAR LAS CASILLAS CORRESPONDIENTES  
 BASINS & FURNITURE / LAVABOS Y MUEBLES  
 LAVABOS CERÁMICOS: DIMENSION 47 CM: A= \_\_\_\_\_ CM B= \_\_\_\_\_ CM h= \_\_\_\_\_ CM  
 MUEBLES DE MADERA: DIMENSION 47 CM: A= \_\_\_\_\_ CM B= \_\_\_\_\_ CM h= \_\_\_\_\_ CM  
 FINISHED / ACABADO:  NATURAL OAK  DARK OAK  BERRY OAK  
 TEXTURA MADERA:  SHADOW  FINISHED  STRIPED  
 OBSERVACIONES: \_\_\_\_\_  
 T: +34 964 914 181 / F: +34 964 914 250 WWW.LIVINGCERAMICS.COM - COMERCIAL@LIVINGCERAMICS.COM

Recommendations / Recomendaciones

Livingceramics recommends consulting the norms that regulate the placement of ceramic tiles. It is essential, before any installation, to carefully read the **UNE 138002 and UNE 12004** standard, and to attend to the specified in order to achieve a correct placement of the ceramic tile. We indicate below, a summary of the most important points to take into account:

Livingceramics recomienda consultar la normativa que regula la colocación de baldosas cerámicas. Es indispensable, antes de cualquier instalación, leer con detenimiento la norma **UNE 138002 y UNE 12004**, y atender a lo especificado con el fin de conseguir una correcta colocación de la baldosa cerámica. Señalamos a continuación, un resumen de los puntos más importantes a tener en cuenta:

Installation Recommendations / Recomendaciones De Instalación

- 1 CONFORMITY OF TONE AND CALIBER OF THE MATERIAL.  
VERIFICAR EL DESTONIFICADO DEL MATERIAL.
- 2 MAKE SURE THAT THE AREA TO CLAD IS CLEAN AND DRY.  
ASEGURAR QUE LA ZONA A REVESTIR ESTÁ LIMPIA Y SECA.
- 3 CEMENT-BASED ADHESIVE SHOULD BE USED FOR EACH TYPE OF PRODUCT; PORCELAIN COLOR BODY OR WHITE BODY.  
UTILIZAR EL ADHESIVO DE CLASE CEMENTO COLA SEGÚN TIPOLOGÍA DE PRODUCTO; PORCELÁNICO MASA COLOREADA O PASTA BLANCA.
- 4 THE AREA TO CLAD MUST BE UNIFORMLY LEVELED. THE USE OF LEVELING SYSTEMS IS MANDATORY FOR A PERFECT INSTALLATION.  
EL USO DE SISTEMAS DE NIVELACIÓN ES OBLIGATORIO PARA UNA PERFECTA COLOCACIÓN. LA ZONA A REVESTIR DEBE ESTAR PERFECTAMENTE NIVELADA.
- 5 A 2 MM MINIMUM JOINT IS RECOMMENDED TO PLACE THE PIECES CORRECTLY.  
SE RECOMIENDA UNA JUNTA MÍNIMA DE 2 MM PARA LA COLOCACIÓN ENTRE PIEZAS.
- 6 THE RECTANGULAR FORMATS CANNOT BE PLACED UNITED TO ANY MORE THAN 1/4 OF THE PIECE.  
LOS FORMATOS RECTANGULARES NO SE PUEDEN COLOCAR TRABADOS A MÁS DE 1/4 DE LA PIEZA.

**THE SLAB INSTALLATION REQUIRES THE USE OF TOOLS AND SPECIFIC TRAINING BY THE INSTALLER. IN ADDITION TO THE ABOVE, THESE ARE SOME OF THE RECOMMENDATIONS TO TAKE INTO ACCOUNT IN THE INSTALLATION OF LARGE TILE FORMATS:**

**LA INSTALACIÓN DE GRANDES FORMATOS REQUIERE DE HERRAMIENTAS Y UNA FORMACIÓN ESPECÍFICA POR PARTE DEL COLOCADOR. A DEMÁS DE LAS ANTERIORES, ESTAS SON ALGUNAS DE LAS RECOMENDACIONES A TENER EN CUENTA EN LA INSTALACIÓN DE GRANDES FORMATOS CERÁMICOS:**



CUTTING DETAIL WITH GUIDE ON SLAB  
DETALLE DE CORTE CON GUÍA SOBRE PLANCHA



THE TILES' DUCTILE PROPERTIES MAKE THEM EASY TO CUT  
LAS PROPIEDADES ESPECIALES DE DUCTILE LO HACEN MÁS FÁCIL DE CORTAR

- 7 THE DOUBLE BONDING TECHNIQUE MUST ALWAYS BE USED.  
SE HA DE EMPLEAR SIEMPRE LA TÉCNICA DEL DOBLE ENCOLADO.

**THE DOUBLE BONDING TECHNIQUE MUST ALWAYS BE USED.  
SE HA DE EMPLEAR SIEMPRE LA TÉCNICA DEL DOBLE ENCOLADO.**

- 8 THIS MATERIAL REQUIRES THE USE OF C2 CLASS ADHESIVES (BICOMPONENT TYPE S2).  
ES RECOMENDABLE EL USO DE ADHESIVOS CLASE C2 ALTAMENTE FLEXIBLES (BICOMPONENTES TIPO S2).

- 9 THE APPEARANCE OF AIR POCKETS BETWEEN TILE AND SUBSTRATE SHOULD BE AVOIDED BY THE SYSTEMATIC KNOCKING OF THE TILE WITH A RUBBER TROWEL. THIS WILL AVOID TENSIONS AND BREAKS AFTER THE MATERIAL HAS BEEN SET.  
SE DEBERÁ EVITAR LA APARICIÓN DE BOLSAS DE AIRE ENTRE BALDOSA Y SUSTRATO MEDIANTE EL GOLPEADO SISTEMÁTICO DE LA CERÁMICA CON UNA LLANA DE GOMA. ESTO EVITARÁ TENSIONES Y ROTURAS TRAS EL FRAGUADO DEL MATERIAL.

- 10 THE USE OF SPECIFIC TOOLS FOR INSTALLING CERAMIC TILES IS MANDATORY. CONSULT YOUR TRUSTED SUPPLIER TO RECEIVE INSTRUCTIONS ON THE CORRECT HANDLING OF THESE TOOLS AND THEIR NEEDS.  
ES INDISPENSABLE UTILIZAR HERRAMIENTAS ESPECÍFICAS PARA EL ALICATADO DEL GRAN FORMATO CERÁMICO. CONSULTE CON SU PROVEEDOR DE CONFIANZA PARA RECIBIR INTRUCCIONES DEL CORRECTO MANEJO DE ESTAS HERRAMIENTAS Y SUS NECESIDADES.

Play Video / Reproducir Video



BIG SLAB INSTALLATION  
INSTALACIÓN DEL GRAN FORMATO

Cleaning & Maintenance / Limpieza & Mantenimiento

Once placed and grout cleaning equipment is mandatory. Improper cleaning may leave traces of products used in the placement or the protection of the tiles, as cements, resins epoxilicas, grout, waxes or fats. For optimal cleaning after placement for cases of intense and stubborn dirt accumulated over time, and for maintenance, required to use the right products. The following table shows some of the recommendations.

Una vez colocado y rejuntado el material es obligatoria la limpieza. Una limpieza incorrecta puede dejar restos de productos empleados en la colocación o de la protección de las baldosas, como cementos, resinas epoxilicas, material de rejuntado, ceras o grasas. Para una optima limpieza tras la colocación, para casos de suciedad intensa e incrustada acumulada en el tiempo, y para su mantenimiento, se precisa emplear los productos adecuados. En la tabla siguiente mostramos algunas de las recomendaciones.

FILACLEANER	MAINTENANCE IN GENERAL. MANTENIMIENTO EN GENERAL.
FILACR10	WASTE EPOXY, VITRIFIED OR RESIN BOARD. RESIDUOS DE JUNTA EPOXI, JUNTA VITRIFICADA O JUNTA RESINOSA.
DETERDEK	WASTE CONCRETE PLACEMENT, LIMESCALE, METALS STRIPES, OXIDE DEPOSITS. RESIDUOS DE CEMENTO DE COLOCACIÓN, RESIDUOS CALCÁREOS, RAYAS METALES, DEPOSITOS DE ÓXIDO.
FILASOLV	CANDLE WAX, TREE RESINS, TAPE RESIDUE, TAR RESIDUE. CERA DE VELAS, RESINA DE ÁRBOL, RESIDUOS DE CINTA ADHESIVA, RESIDUOS ALQUITRÁN.
FILANOPAINT STAR	PAINTED GRAFFITI, SPRAY ACRYLIC, ALKYD AND SYNTHETIC NITROS. PINTADAS DE GRAFITIS, SPRAY ACRÍLICOS, ALQUÍDICOS Y NITROS SINTÉTICOS.
FILAPS87	DRINKS, FOOD, FATS, OILS, RUBBER, DYES, MARKER, ACRYLIC PAINT DROPS. BEBIDAS, COMIDAS, GRASAS, ACEITES, GOMA, TINTES, ROTULADOR, GOTAS DE PINTURA PLÁSTICA.

**THE FOLLOWING GENERAL TERMS AND CONDITIONS GOVERN SALES BETWEEN LVG Ceramic Surfaces. S.L. AND ITS CLIENTS.****1. Orders**

The parties' obligations concerning deliveries of goods (the transfer of responsibilities, expenses, insurance, customs procedures etc.) shall be those deriving from the agreed specific terms and conditions (INCOTERMS 2020). Barring possible agreed written amendments or exceptions, the general terms and conditions outlined herein shall regulate all sale agreements between our company and the buyer and hence both the contractual agreement that was reached on acceptance of this order and any future agreement for the supply of products by our company through successive different orders. Variations in the general sales conditions and in any sales offers, transactions, credit notes or discounts agreed upon by our Agents or by other intermediaries shall only be deemed to be valid once they have been accepted in writing by our head office and, in all such cases, this written acceptance shall only apply to the related agreement.

**2. Supplies and deliveries of goods**

On reception of a delivery of goods, the buyer shall immediately inspect them for flaws or defects. LVG Ceramic Surfaces. S.L. must be given written notice of any external or visible flaws within

fifteen (15) days of the reception of the goods. In the case of hidden flaws, the deadline for claims shall be thirty (30) days from the reception of the goods. If no notice of any flaws is given by the buyer within the said deadlines, the latter shall be deemed to have approved the goods. The buyer of a faulty product must make a claim within the aforementioned stipulated period, opting for one of the following possible solutions:

1. The delivery of a new product in exchange for the return of the faulty one.
2. A refund of the price that was paid in exchange for the return of the faulty product.

The distributor shall be liable for attaching the warranty, technical specifications and product care instructions to the invoice given to the client.

**3. Returns**

Faulty goods must be returned in the same state and packaging in which they were received. Orders received directly from clients or placed on the latter's behalf by our representatives shall always be subject to our acceptance. The acceptance of a return by LVG Ceramic Surfaces. S.L. does not mean that it admits or agrees to the claim for the faulty product. In the event of mistakes in the number of goods that are supplied, the buyer shall only be entitled to claim for the number that was not delivered. The

el comprador no realiza notificación alguna de defectos en dichos plazos, la mercancía se considerará conforme. La parte compradora de una mercancía que se encuentre en estado defectuoso, como se ha indicado, debe reclamar en plazo y optar a las siguientes vías de solución:

1. La entrega de una mercancía nueva a cambio de la devolución de la defectuosa.
2. Reintegro del precio abonado a cambio de la de la devolución de la defectuosa.

Por otra parte, el distribuidor se responsabiliza de adjuntar en la factura que debe dar al cliente tanto la Garantía, como las especificaciones técnicas y mantenimiento del mueble.

**3. Devolución**

La mercancía defectuosa debe devolverse en el estado y con en el embalaje mediante el cual ha sido entregada. Los pedidos recibidos directamente de los clientes o realizados por nuestros representantes en nombre de ellos siempre estarán sujetos a nuestra aceptación. Se tiene en cuenta que la realización de una devolución aceptada por LVG Ceramic Surfaces. S.L. no significa que se asuma o reconozca la reclamación debida a defectos en la mercancía. En caso de defectos en la cantidad suministrada, el comprador tendrá únicamente derecho a poder reclamar la cantidad no entregada. El responsable de la entrega del residuo de envase o envase usado para su correcta gestión ambiental será el poseedor final del mismo.

final recipient of the used packaging or packaging waste shall be responsible for its delivery to the appropriate environmental waste management service.

**4. Deliveries**

Goods delivered by LVG Ceramic Surfaces. S.L. are subject to retention of title. The ownership of the goods shall only be transferred to the buyer when they have been fully paid for. LVG Ceramic Surfaces. S.L. shall be entitled to offset any sum owed to it by the buyer against any sum payable by the company to the buyer. In the event of failure to comply with the conditions regarding the payment and/or return of the agreed goods, the buyer shall be liable for the cost of their return, plus any expenses of an administrative nature or costs derived from legal claims, including the fees of solicitors and court representatives. In the event of a delay in the payment of goods by the buyer, the seizure of the latter's goods or a substantial decline in the buyer's financial situation, LVG Ceramic Surfaces. S.L. shall be entitled to claim immediate payment of the invoiced amount, to withhold all pending supplies and services, to condition the delivery of goods—once the buyer is no longer in arrears—upon their advance payment and, if applicable, to claim for any corresponding compensation. Under no circumstances may the goods be resold through a website (online sales). Unless agreed otherwise, the buyer shall be forbidden from

exporting materials supplied by LVG Ceramic Surfaces. S.L. and from making them available to companies or individuals who go on to export them.

**5. Competent jurisdiction**

The resulting relations between the parties shall be subject to the legislation of the Kingdom of Spain. Both parties expressly waive their right to any other corresponding jurisdiction and they agree to abide by the decisions of the Vila-real Law Courts (Castellón) in the settlement of any dispute, controversy or claim that might arise in connection with the said commercial relations.

**6. Data protection**

In accordance with Spanish Data Protection Act 15/1999 of December 13th, the personal data supplied by the buyer shall be entered in LVG Ceramic Surfaces. S.L.'s client file for the purpose of managing contractual relations and controlling and managing sales and the corresponding collection of payment. LVG Ceramic Surfaces. S.L. shall process the said data with all due confidentiality and it undertakes not to use the said information for any other purpose than that cited above. Likewise, it agrees to take the necessary steps to keep the data safe and to avoid its alteration, loss, and unauthorized access or processing. The buyer shall be entitled to exercise its right of access, rectification, cancellation and objection by giving written notice to LVG Ceramic Surfaces. S.L..

**4. Entrega**

Las mercancías entregadas por LVG Ceramic Surfaces. S.L. están sujetas a reserva de dominio. La propiedad de la mercancía únicamente pasará al comprador en el momento en que esté completamente pagada. LVG Ceramic Surfaces. S.L. tiene derecho a compensar cualquier suma que le adeude el comprador contra cualquier suma que resulte pagadera al comprador. En caso de incumplimiento de las condiciones de pago y/o devolución de los efectos negociados, serán de cuenta del comprador los gastos de devolución más los gastos de administración y reclamación judicial que se originen en su caso, incluidos los honorarios de letrados y procuradores. En caso de mora en el pago de la mercancía por el comprador, así como si sufriera embargo en sus bienes o si se produjera un empeoramiento sustancial de su situación patrimonial, LVG Ceramic Surfaces. S.L. estará facultada para reclamar el pago inmediato del importe facturado y retener todos los suministros y prestaciones pendientes y condicionar la entrega de las mercaderías - aun cuando el comprador ya no se encuentre en mora - al pago por adelantado de las mismas así como, en su caso, a reclamar la indemnización correspondiente. En ningún caso la mercancía podrá ser objeto de reventa mediante el uso de una página web (venta online). Siempre que no existan acuerdos contrarios, se prohíbe al Comprador exportar los materiales que le suministre nuestra empresa, o cedérsela a empresas o personas que los exporten.

**5. Tribunal competente**

Las partes someten las relaciones resultantes entre las mismas a lo dispuesto en la Legislación del Reino de España y, con renuncia expresa al propio fuero que pudiera corresponderles, se someten a los juzgados y tribunales de Vila-real (Castellón) para resolver cualquier controversia, conflicto o reclamación que surja en conexión con la relación comercial establecida entre las mismas.

**6. Protección de Datos de Carácter Personal**

Conforme a la Ley Orgánica de 15/1999 de 13 de diciembre de Protección de Datos de Carácter Personal, los datos de carácter personal facilitados por el comprador formarán parte del fichero de clientes de LVG Ceramic Surfaces. S.L., cuyos fines son el mantenimiento de la relación contractual, el control y gestión de las ventas y sus correspondientes cobros. LVG Ceramic Surfaces. S.L. tratará dichos datos con la máxima confidencialidad, y se compromete a no utilizarlos con un fin distinto a aquel para el que han sido recabados, así como a conservarlos con las debidas medidas que garanticen su seguridad y eviten su alteración, pérdida, tratamiento o acceso no autorizados. El comprador tiene la posibilidad de ejercitar los derechos de acceso, rectificación, cancelación y oposición dirigiendo una comunicación por escrito a LVG Ceramic Surfaces. S.L..

# CONTEMPORARY MIXTURES SURFACES & SIGNATURE SURFACES

2023 EDITION I / 2023 EDICIÓN I

## Livingceramics

### Headquarters, Showroom and Warehouse

Oficinas, Showroom Y Almacén

Ctra. Vila-real – Onda CV 20 KM 2.5  
12540, Vila-real, Castellón, Spain

### Production Center

Centro De Producción

Ctra. Onda – Ribesalbes CV 191 KM 3  
12200, Onda, Castellón, Spain

[www.livingceramics.com](http://www.livingceramics.com)  
[info@livingceramics.com](mailto:info@livingceramics.com)

Tel. +34 964 914 181  
Fax. +34 964 914 250

Legal Information  
Información Legal

LVG Ceramic Surfaces. S.L. reserves the right to make changes and modifications deemed necessary. Because of the printing process, the colors shown in this catalog are approximate, not exact. The information in this catalog is fully protected by copyright. Total or partial reproduction of text, illustrations, images and graphical representations is forbidden without the express permission of Livingceramics.

LVG Ceramic Surfaces. S.L. se reserva el derecho de hacer variaciones y modificaciones que considere oportunas. A causa de los procesos de impresión, los colores que aparecen en este catálogo deben considerarse aproximados, no exactos. La información de este catálogo está protegida en su totalidad por copyright. Está prohibida la reproducción total o parcial de los textos, ilustraciones, imágenes y representaciones gráficas sin la autorización expresa de Livingceramics.



INNOVATIVE SME



### SME INNOVATIVE / PYME INNOVADORA

The Spanish Ministry for Science, Innovation & Universities rewards Livingceramics efforts in the fields of R&D and innovation. This mention is the outcome of the incorporation of state-of-the-art technology to our production plant in order to produce large-format tiles conspicuous for their unique finishes.

El Ministerio de Ciencia, Innovación y Universidades reconoce a Livingceramics la inversión en investigación y Desarrollo de productos diferenciadores en la industria cerámica actual. Se trata de un reconocimiento estatal que verifica la inversión realizada por la empresa en su proceso de producción y búsqueda continua. Galardona así la innovación y el esfuerzo realizado por Livingceramics a la hora de invertir en I+D+i.



What you have seen here is the result of enthusiasm, passion, creativity and perseverance. To give technology a twist and experiment with it. We hope you enjoyed it as much as we did in the process.

Lo que has visto aquí es fruto de la ilusión, la pasión, la creatividad y la constancia. De darle un giro a la tecnología y experimentar. Esperamos que lo hayas disfrutado tanto como nosotros al crearlo.

**Living**ceramics